

BRACKETT AIR FILTERS

APPLICATION DATA

MANUFACTURERS AIRCRAFT MODELS	BRACKETT FILTER ASSY. NO.	BRACKETT ELEMENT NUMBER
AERO COMMANDER		
A-9, A9A, A9B	BA-104	BA-3
100, 100A	BA-8910	BA-8905
100-180	BA-3910	BA-3905
112, 112A, 112B	BA-3910	BA-3905
112TC, 112TC-A, 114, 114A	BA-4010	BA-4005
500	BA-152	BA-152E
500A, 500B, 560F, 680F, 680FL	BA-151	BA-151E
680FLP, 500U	BA-151	BA-151E
560, 560A, 560E, 680	BA-2610L&R	BA-2605L&R
AIRCOUPE		
415C, CD, D, E, G	BA-8810	BA-8805
F-1, A-1, A2-2	BA-4106	BA-4108
BEECH		
23, A23, A23A	BA-104	BA-3
A23-19, A23-19A		
A23-24, B23		
C-23, C24R, A24R	BA-7510	BA-7305
B24R, B19		
33, A33, B33		
C33, E33, F33	BA-7110	BA-7112
C33A, E33A, E33C	BA-7210	BA-7112
F33A, F33C, G33		
35, A35, B35		
thru S/N D2605	BA-7310	BA-7305
B35, C35, D35, E35, F35		
G35, H35, J35, K35	BA-7110	BA-7112
M35, N35, P35, 35R		
S35 thru	BA-7410	BA-7112
S/N D7671		
S35, V35, V35A, V35B, 36	BA-7210	BA-7112
A36, A36TC, B36TC, A45(T-34)		
B45(T-34A), D45(T-34B)		
W/STC SA 1450 SW CONT IO-520		
T34A, B, B-45, A45, D45	BA-5910	BA-5905
with CONT 0-470-4, -13, -13A (PENDING)		
50, B50, C50, D50, D50A		
D50B, D50C, D50E	BA-4810	BA-4805
E50 (L-23D, RL-23D),	BA-100	BA-7
F50, G50, H50, J50		
55, A55, B55	BA-7610	BA-7605
C55, D55, E55, 355A		
S/N TE768-1078	BA-6210-1	BA-6205
58, thru S/N TH 740		
E55, 355A, S/N	BA-7710	BA-7705
TE-1079 & up		
58, 58A, S/N	BA-7710	BA-7705
TH741 & up		
A65, 70	BA-100	BA-7
65-B80, B88		
76	BA-7010	BA-7005
77	BA-2010	BA-6108
95, B95, B95A, D95A	BA-7810	BA-7805
BELL		
47G-2, 2A, -2A-1	BA-102	BA-2
47G-3, -3B, -3B-1, -3B-2, -3B-2A		
47J, 47J-2, 47J-2A		
47G-3B, 3B-1, 3B-2, -4, -4A,	BA-103	BA-9
-5; 47J-2, -2A		
BELLANCA		
14-19-3A	BA-8110	BA-8103-1
17-30	BA-8110	BA-8103-1
17-30A	BA-104	BA-3
17-31A, -ATC	BA-249	PEND
BRANTLY		
B-2, B-2B	BA-104	BA-3
BRITTEN NORMAN		
BN-2A-6 with Lycoming		
0-540-E4C5 Engines		
BN-2, 2A, 2A-2, 2A-3, 2A-8	BA-104	BA-3
2A-9, 2A-20, 2A-21, 2A-27		
2B-20, 2B-21, 2B-26, 2B-27		

MANUFACTURERS AIRCRAFT MODELS	BRACKETT FILTER ASSY. NO.	BRACKETT ELEMENT NUMBER
CESSNA		
120, 140, 140A, 150, 150A	BA-4106	BA-4108
B, C, D, E, F, G, H, J, K, L, M		
A150M, 152, A152		
F150G, H, J, K, L, M		
FA150K, L, F152, FA152		
170, 170A, B, 172, 172A	BA-5110	BA-6108
B, C, D, E, F, G, H, I, K, L, M		
F172D, E, F, G, H, K, L, M		
172N, P, F172N, P	BA-5110A	BA-6108
R172K, FR172E, F, G, H, J, K	BA-111	BA-24
172 RG	BA-5810	BA-5805
175, 175A, B, C	BA-101	BA-8
177, 177A, B, RG, F177RG	BA-5710	BA-5705
180, (53'-55')	BA-8010	BA-8005
180A, B, C, D, E, F, G, H, J, K	BA-8110	BA-8103-1
182, 182A, B, C, D, E, F	BA-8110	BA-8103-1
G, H, J, K, L, M, N, P, Q, R		
F182P, F182Q		
R-182, TR-182, T-182, FR182	BA-2510	BA-2505
185, 185A, B, C, D, E		
A185E, A185F	BA-8110	BA-8103-1
188, 188A	BA-114	BA-14A
190, 195, A, B	BA-8410	BA-8405
205, A	BA-2110	BA-2305
P206, A, B, C, D, E	BA-2210L	BA-2205L
U206A, B, C, D, E, F, G		
TP206, A, B, C, D, E	BA-2410	BA-2405
TU206A, B, C, D, E, F, G		
207, 207A	BA-2210L	BA-2205L
T207, T207A	BA-2410	BA-2405
210, 210A, B, C,	BA-2110	BA-2305
210D, E, F, G, H, J, K, L, M, N	BA-2210L	BA-2205L
(To S/N 64535 w/o AIR)	BA-2210R	BA-2205R
210N (S/N 64536 & up	BA-2410	BA-2405
with AIR)		
P210 All	BA-8710	BA-8705
T-210F, G, H, J, K, L, M, N	BA-2410	BA-2405
T-303	BA-5210	BA-5205
310, A, B	BA-2110	BA-2305
310F, G, H, I, J, K, L	BA-2310	BA-2305
310N, P, Q, T310P, T310Q	BA-107	BA-12
310R	BA-117	BA-17
T310R	BA-108	BA-13
336	BA-111	BA-24
337, A, B, C, D, E, F, G, H	BA-111	BA-24
F337E, F, G, H		
P337, T337 Rear Engine	BA-5810	BA-5805
340, 340A	BA-109	BA-22
401 S/N 145 TO 401B S/N 221	BA-107	BA-12
402 S/N 145 TO 402B S/N 800	BA-107	BA-12
402B S/N 0801 & up	BA-108	BA-13
402C	BA-109	BA-22
404	BA-130	BA-30

MANUFACTURERS AIRCRAFT MODELS	BRACKETT FILTER ASSY. NO.	BRACKETT ELEMENT NUMBER
411, 411A	BA-3810	BA-3805
414, A	BA-109	BA-22
421, 421A, B, C	BA-108	BA-13
L-19	BA-101	BA-8
T41B, C, D,	BA-111	BA-24
T-50, AT-17, UC-78, JRC-1	BA-2710	BA-2705
CHAMPION		
8KCAB, 8GCBC	BA-8110	BA-8103-1
7KCAB, 7GCBC	BA-8110	BA-8103-1
7GCAA		
7GCAA, 7GCBC	BA-106	BA-11
7KCAB, 8KCAB	BA-106	BA-11
7ECA		
7GC, 7GCA, 7GCBC, 7GCB	BA-104	BA-3
7HC, 7KC	BA-104	BA-3
7ECA w/Cont. 0-200-A		
7ACA, 7ECA, 7FC, 65CA	BA-4106	BA-4108
DEHAVILLAND		
DHC-2(L-20)	BA-8210-1	BA-8205
GREAT LAKES		
2TIA-2	BA-101	BA-8
GRUMMAN AMERICAN		
AA-1, AA-1A, AA-1B	BA-4210	BA-4108
AA-1C, AA-5		
AA5A	N/R	BA-19
AA5B TIGER, GA-7	BA-120	BA-20
AGCAT		
G164, G164A, G164B TO S/N 1-176	BA-8210	BA-8205
G164B S/N 177 & UP	BA-105	BA-10
HILLER		
UH-12, UH-12A, B, C, D, E	BA-102	BA-2
HELIO		
H295	N/R	BA-21
HUGHES		
269A, A-1, B, C	BA-102	BA-2
LAKE		
LA4, LA4-200	BA-3110	BA-7305
LUSCOMBE		
8, 8A thru 8F, T8F	BA-4106	BA-4108
MAULE		
M-4-210, M-4-210C	BA-111	BA-24
M-4-210S, M-4-210T		
M-5-210C		
MA-4, M-4C, M-4S, M-4T	BA-6110	BA-6108
M-4-220, M-4-220C		
M-4-220S, M-4-220T		
M-4-180C, M-4-180S		
M-4-180T, M-5-220C		
M-5-235C, M-5-180C		
M-5-210TC, M-6-180		
M-6-235, MX7-180, M-7-235		
MOONEY		
M-10	BA-4106	BA-4108
M-18C	BA-5110	BA-6108
M20, M20A, B, C, D, G	BA-6110	BA-6108
M20E, F	BA-6310	BA-6305
M20J	BA-6210	BA-6205
NAVION		
B, G, H	BA-4310	BA-4305
A	BA-113	BA-25
B w/Lyc. GO-435	BA-116	BA-26

BRACKETT AIR FILTERS

APPLICATION DATA CONTINUED

MANUFACTURERS AIRCRAFT MODELS	BRACKETT FILTER ASSY. NO.	BRACKETT ELEMENT NUMBER
NORTH AMERICAN AT6 (SNJ)	BA-8310	BA-8305
PARTENAVIA P68, P68B, P68C	BA-162	BA-162E
PIPER 600, 601	N/R	BA-4
J-3, J-4, J-5	BA-4106	BA-4108
PA-11, 11S, 12, 12S	BA-4106	BA-4108
PA-16, 17, 18	BA-4106	BA-4108
PA-18-"150", PA-18A-"150" PA-18S-"150", PA-18AS-"150" S/N 18-6964 & UP WITH TCDS ITEM 110 INSTALLED	BA-112	BA-13
PA-19	BA-4106	BA-4108
PA-20, 115, 135 PA-22-ALL	BA-4106 BA-4106	BA-4108 BA-4108
PA-23, 160	BA-3110A	BA-7305
PA-23-235, 250	BA-104	BA-3
PA-23-250, PA-E23-250 S/N 27 2505 & Up	BA-115	BA-15
PA-23-250, E23-250 w/TURBO LYC.	BA-3510	BA-3505
PA-23-250 with AIR RESEARCH TURBO	BA-8610	BA-8605
PA-24-180 Up to S/N 1476	BA-3110A	BA-7305
PA-24-250 Up to S/N 1476	BA-3210	BA-3205

MANUFACTURERS AIRCRAFT MODELS	BRACKETT FILTER ASSY. NO.	BRACKETT ELEMENT NUMBER
PIPER (continued)		
PA-24-180 & PA-24-250 S/N 1477 & Up, PA-24-250 S/N 103-1476 with Piper Kit 754-285 Installed, PA-24-260 S/N 4000-4802 Except 24-4783	BA-104	BA-3
PA-24-260C	BA-4510	BA-4505
PA-25-235, 260	BA-104	BA-3
PA-28-140, 150, 160, 180, 235	BA-104	BA-3
PA-28-181, 201T	BA-104	BA-3
PA-28R-201T	BA-104	BA-3
PA-28RT-201T	BA-104	BA-3
PA-28R-201, PA-28RT-201 PA-28R-180, PA-28R-200	BA-105	BA-10
PA-28-151, 161	N/R	BA-16
PA-28-236 S/N 28-7911283 & Up	BA-2910	BA-2905
PA-30-160	BA-105	BA-10
PA-30, With Ray Jay Turbo	BA-121	BA-27
PA-31, PA-31-300, -310, -325, -350	BA-100	BA-7
PA-31P, 31P-350	BA-3310	BA-3306
PA-32-260	BA-104	BA-3
PA-32-300 S/N 76-40001 & Up PA-32R-300, PA-32RT-300, PA-32R-301	BA-104	BA-3

MANUFACTURERS AIRCRAFT MODELS	BRACKETT FILTER ASSY. NO.	BRACKETT ELEMENT NUMBER
PIPER (continued)		
PA-32-300 w/10-540-K1A5	BA-115	BA-15
PA-32RT-300T	BA-100	BA-7
PA-32-301T, 32R-301T TO S/N 3229003	BA-3010	BA-7
PA-34-200T, 220T	BA-104	BA-3
PA-34-200 w/LYC 10360C01E6 or L10-360-C1E6	BA-105	BA-10
PA-36-300 w/Cont 6-285-B, PA-36-375	BA-104	BA-3
PA-38	BA-4106	BA-4108
PA-39	BA-105	BA-10
PA-39 w/Ray Jay Turbo	BA-121	BA-27
PA-44-180	BA-105	BA-10
PA-44-180T	BA-3510	BA-3505
ROBINSON R-22	BA-110	BA-23
STEARMAN ALL SERIES 75	BA-118	BA-18
STINSON 108, 108-1, -2, -3,	S-108K BA-9110	BA-9105
SWIFT GC-1A, GC-1B	BA-4106	BA-4108
TAYLORCRAFT	BA-4106	BA-4108
VARGA 2150A	BA-4106	BA-4108

INSTALLATION TIPS

- In cases where the filter frame is to be attached, occasionally a broken or bent airloc fastener is found. Restoring the ability to secure the filter is of prime importance, any good method of bolting or screwing the frame on is acceptable.
- Check to make sure that the gasket makes good contact around the periphery and it's compressed to approximately 1/2 the original thickness.
- If the element wettant congregates to one end, blot the excess with clean dry cloth. If your installation tools encounter wettant, WD-40 will help with clean up.
- Check and be sure the rest of the air intake is in good shape and look for torn rubber couplings, worn carburetor heat valve, or alternate air doors. With these in good condition, you can feel confident your engine is operating in a clean air environment.
- For continued inservice instructions, reference Form I-194 located on the back side of the Filter Element Bag.

BRACKETT AIR FILTERS

STYLES

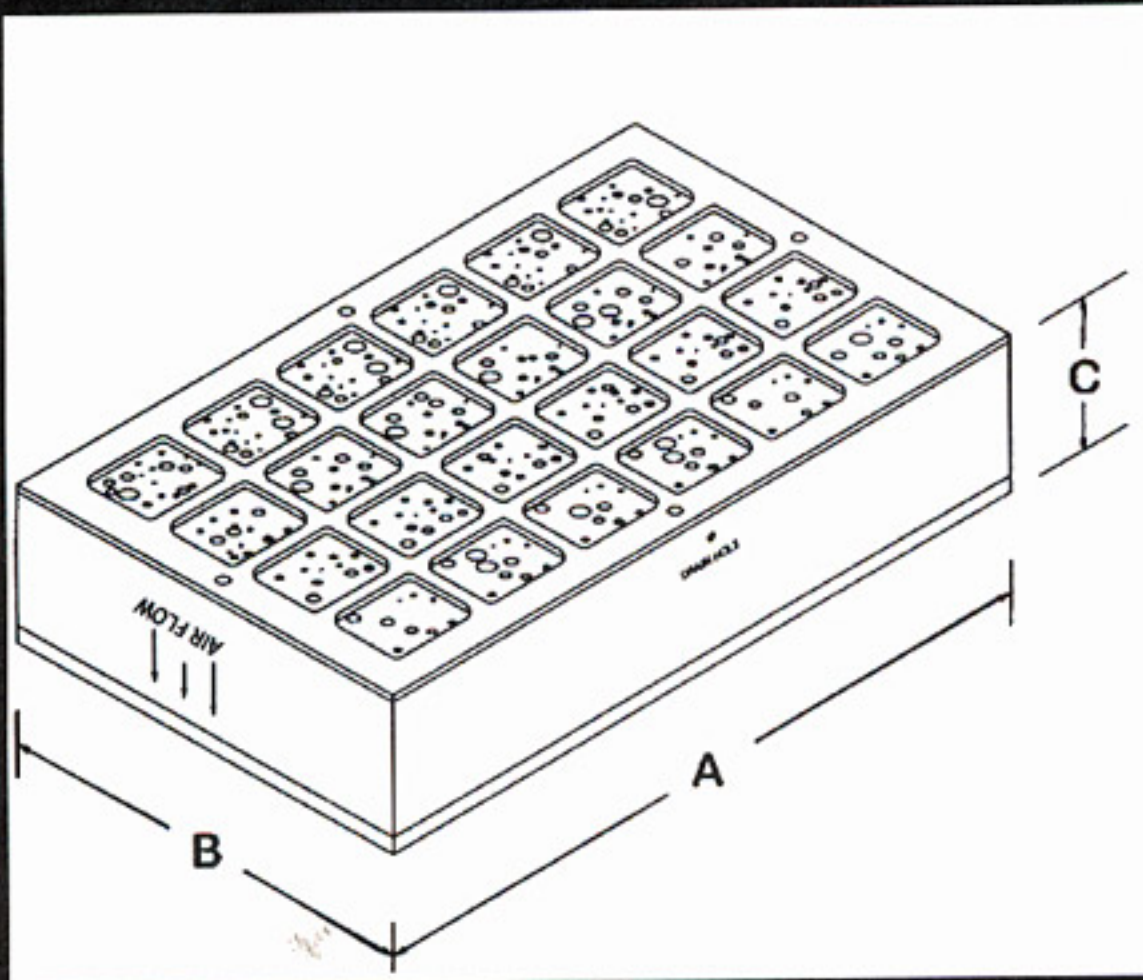

STYLE I

External Frame—Rectangle or Square

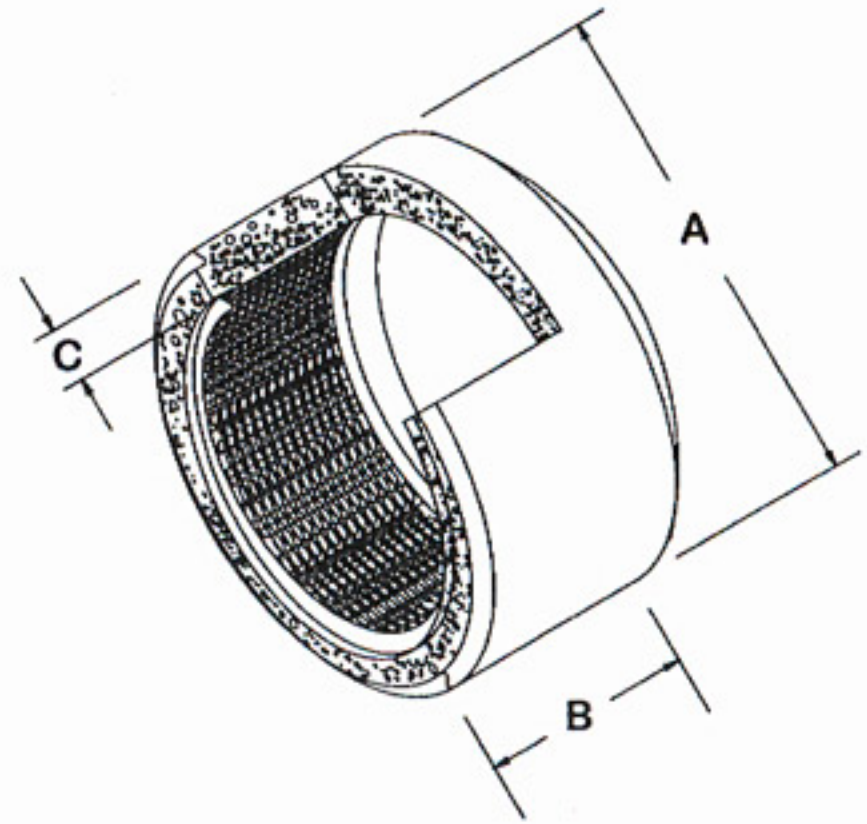

STYLE II

Foam Element on outside of Steel Screen Cylinder—Round or Oval

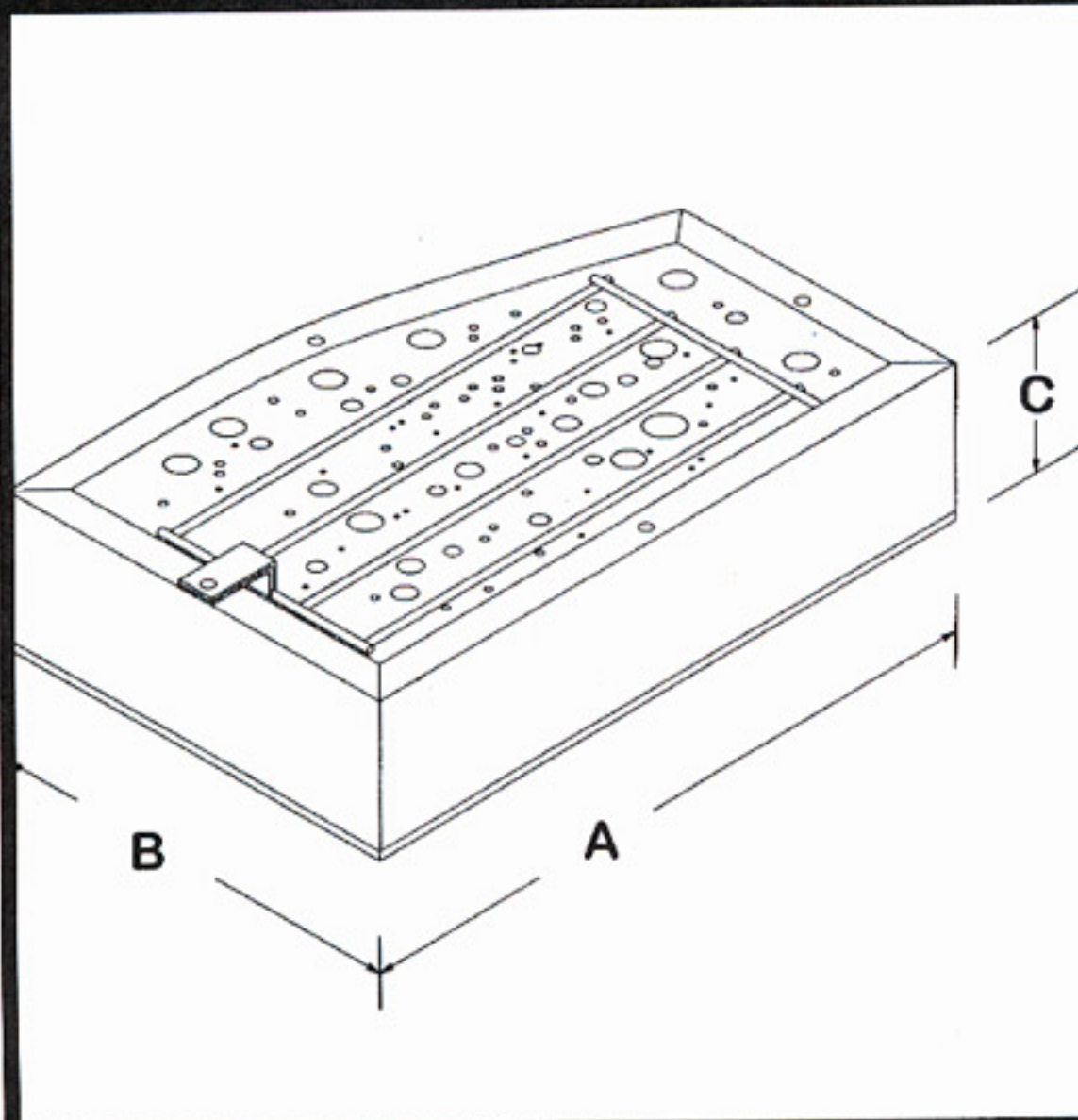

STYLE III

External Frame—Irregular Shape

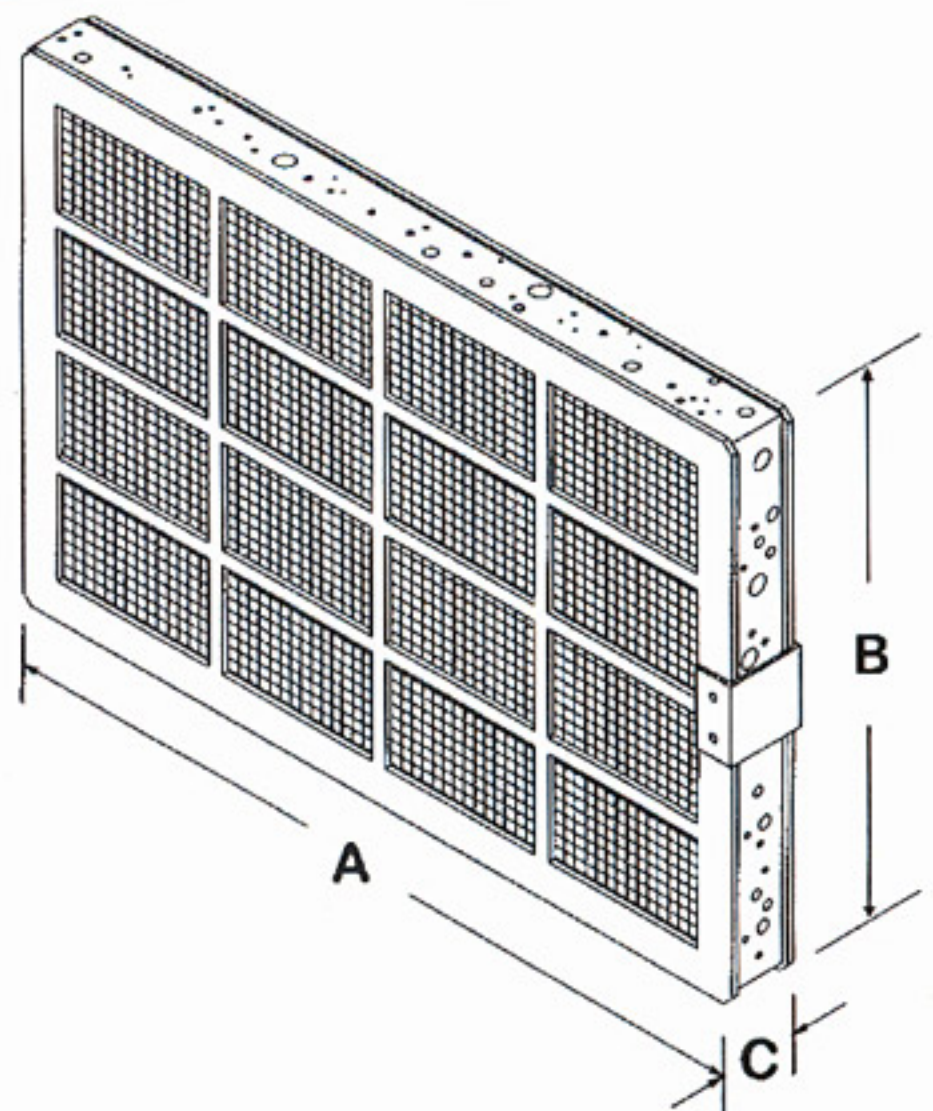





STYLE IV

Slide In Style—Various Shapes

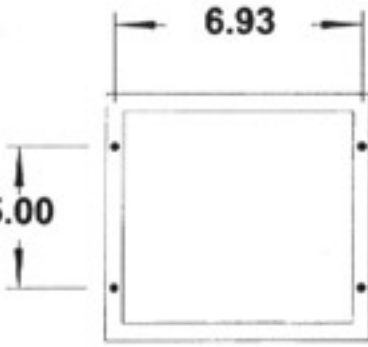



BRACKETT AIR FILTERS

SPECIFICATIONS

ASSEMBLY	STYLE	DIMENSIONS			BASE ATTACHMENT DIMENSIONS	X-REF FILTER PART NO.	ELIGIBLE MODELS
		A	B	C			
BA-100 ELEMENT BA-7 FR GRILL BA-1001 GASKET BA-1003 INST. SHEET BA-1005 STC: SA693CE	I	10 ^{7/8}	6 ^{3/8}	2		BEECH 50-389070-1 50-389070-5, -9, -11 PIPER 460-817 P10-6590 PIPER 560-747 AC-6484696 AM-125400-4 AM-125400-005	BEECH "TWIN BONANZA": E50 (L-230, RL-230) F50, G50, H50, J50 BEECH "QUEENAIR": A65-70, 65-88, B-80 PIPER "NAVAJO" & "CHIEFTAIN" PA-31, PA-31-300, PA-31-350, PA-31-310, PA-31-325, "LANCE" PA32RT-300T
BA-101 ELEMENT BA-8 FR GRILL BA-1101 GASKET BA-1102 INST. SHEET BA-1105 STC: SA693CE	I	7 ^{1/2}	7	1		CESSNA 120009 AM 120009 TYPE P57A CESSNA 120009A AM 124748-035 TYPE P1A AC-6486197	CESSNA "SKYLARK": 175, 175A, 175B, 175C, L-19* GREAT LAKES: 2T-1A-2 *Listed on T.C. as AC 6486197
BA-102 ELEMENT BA-2 DUAL STAGE INST. SHEET BA-102-3 STC: SH12CE	II	8 ^{1/8}	4 ^{1/8}	1		FRAM 1800 HUGHES 269-A-8156 PUROLATOR 51845 AC-6422370 HILLER 51845 FRAM 143100	BELL: 47G-2, -2A, -2A-1; 47G-3, -3B, -3B-1, -3B-2, -3B-2A; 47J, 47J-2, 47J-2A HILLER: UH-12, UH 12A, B., C, D, E HUGHES: 269A, A-1, B, C
BA-103 ELEMENT BA-9 INST. SHEET BA-103-3 STC: SH12CE	II	8 ^{7/8}	5 ^{3/4}	1		BELL 4115-2407 FRAM CA-108PL FRAM 4079 AC-6486180	BELL: 47G-3B, 3B-1, 3B-2, -4, -4A, -5; 47J-2, -2A
BA-104 ELEMENT BA-3 INST. SHEET BA-104-3 STC: SA693CE	II	6 ^{5/8} .11	3 ^{5/8}	1		BEECH 169-380011 PIPER 460-632 PIPER 89308-00 FRAM CA 161PL PURO-AFP-2 AC-6485710	AERO COMMANDER "SPARROW" & "QUAIL": A-9, A9A, A9B BEECH "MUSKETEER": 23; A23; A2, A23A; A23-19, -19A, -24; B23 BRANTLY: B2B BRITTEN NORMAN "ISLANDER": BN-2, 2A, 2A-2, 2A-3, 2A-4, 2A-5, 2A-6, 2A-7, 2A-8, 2A-9, 2A-20, 2A-21, 2A-27, 2B-20, 2B-21, 2B-26, 2B-27 PIPER: PA-23-235, -250 S/N 27-1 thru 27-2504, PA-24-180, 250 S/N 1477 AND UP; PA-28-140, -150, -160, -180, -181, -201T, -235; PA-28R-201T; PA-28RT, -201T; PA-32-260, -300 S/N 32-7640001 & UP; PA-32R-300, -301; PA-32RT-300; PA-34-200T, 220T; PA-36-300 with CONT 6-285-B, -375



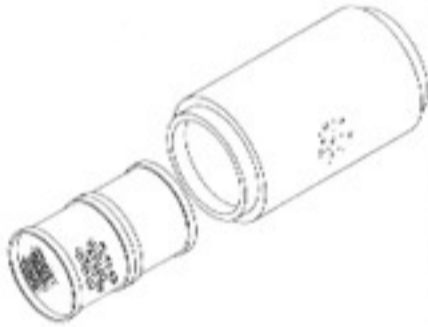
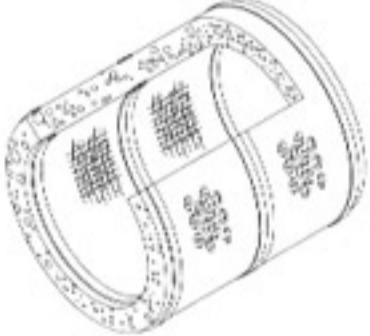

BRACKETT AIR FILTERS

SPECIFICATIONS

ASSEMBLY	STYLE	DIMENSIONS			BASE ATTACHMENT DIMENSIONS	X-REF FILTER PART NO.	ELIGIBLE MODELS
		A	B	C			
BA-105 ELEMENT BA-10 INST.SHEET BA-105-3 STC: SA693CE	II	8	3 ^{3/4}	1		PIPER 460-630 FRAM CA-144PL AC-6422370	PIPER: PA-28R-180, -200, -201; PA-28RT-201; PA-30; PA-34-200 with LYC IO-360-C1E6 or LIO-360-C1E6 ENGINE; PA-39; PA-44 GRUMMAN "AG CAT": G164B
BA-106 ELEMENT BA-11 INST. SHEET BA-106E STC: SA693CE	II	6	3 ^{1/2}	1		FRAM CA-121PL AC-6486786	BELLANCA/CHAMPION: 7ECA; 7GCAA; 7GCBC; 7KCAB; 8KCAB
BA-107 ELEMENT BA-12 INST. SHEET BA-107-E STC: SA71GL	III	6	7 ^{1/4}	1		CESSNA 9910018-2	CESSNA: 310N, P, Q, T310P, Q CESSNA: 401 S/N 145 THRU 401A, 401B S/N 221 CESSNA: 402 S/N 145 THRU 402A, 402B S/N 800
BA-108 ELEMENT BA-13 INST. SHEET BA-108-E STC: SA71GL	II	6	9 ^{1/4}	1		CESSNA 9910018-1	CESSNA: T310R CESSNA: 402B S/N 0801 & UP ALL AIRCRAFT MOD. WITH KIT: SK 402-27 CESSNA: 421, 421A, B, C AND ALL A/C with MOD KIT SK 402-27
BA-109 ELEMENT BA-22 INST. SHEET BA-109-5 STC: SA71GL	II	10 ^{1/4}	3 ^{1/2}	1		CESSNA 9913001-1 P12-8156 AM 228AM 103535-1A	CESSNA: 340, 340A CESSNA: 402C CESSNA: 414, A

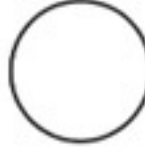



BRACKETT AIR FILTERS

SPECIFICATIONS

ASSEMBLY	STYLE	DIMENSIONS			BASE ATTACHMENT DIMENSIONS	X-REF FILTER PART NO.	ELIGIBLE MODELS
		A	B	C			
BA-110 ELEMENT BA-23 INST. SHEET BA-110-5 STC: SH12CE	II	8 ^{1/8}	3 ^{1/8}	1		ROBINSON A-152C	ROBINSON: R-22
BA-111 ELEMENT BA-24 END CAP 111-7 INST. SHEET BA-111-D STC: SA71GL	II	4 ^{5/8}	5 ^{3/4}	1		CESSNA C294510-0401 P10-7336 AM 102635EA 202036	CESSNA: R172K REIMS CESSNA: FR172E, F, G, H, J, K CESSNA: T41B, C, D CESSNA: 336 CESSNA "SKYMASTER": 337, A, B, C, D, E, F, G, H MAULE: M-4-210, 210C, 210S, 210T, M-5-210C
BA-112 ELEMENT BA-13 CAP BA-112-G INST. SHEET BA-112-5 STC: SA71GL	II	6 ^{1/4}	8 ^{1/2}	1		PIPER 454-118 FRAM CA 122PL	PIPER "SUPER CUB": PA18A SUPER CUB, PA-18-150, 18A-150, 18S-150, 18AS-150, SN-18-6964 & UP WITH ITEM 110
BA-113 ELEMENT BA-25 INST. SHEET BA-113-6 STC: SA71GL	IV		6 ^{1/2}	2		NAVION 145-42103 FARR 48416-A-2578-1	NAVION, A, (E SERIES ENGINE)
BA-114 ELEMENT BA-14 INST. SHEET BA-114-04 STC: SA693CE	II	10 ^{1/4}	3 ^{1/2}	1		CESSNA 294510-0101 AC-6487460	CESSNA AG-WAGON: 188, 188A

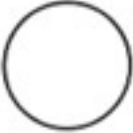



BRACKETT AIR FILTERS

SPECIFICATIONS

ASSEMBLY	STYLE	DIMENSIONS			BASE ATTACHMENT DIMENSIONS	X-REF FILTER PART NO.	ELIGIBLE MODELS
		A	B	C			
BA-115 ELEMENT BA-15 INST.SHEET BA-115-3 STC: SA693CE	II	10	3 ^{3/8}	1		PIPER 460-629 32198-00 FRAM CA-162PL AC-6487894	PIPER "AZTEC": PA-23-250, 23E-250 S/N27-2505 AND UP PIPER "CHEROKEE 6": PA32-300 w/LYC ID-540-K1A5 S/N 32-40000 THRU 32-7540198
BA-116 ELEMENT BA-26 INST. SHEET BA-116-6 STC: SA71GL	IV		7 ^{3/4}	2		NAVION 146-42103	NAVION B (GO-435)
BA-117 ELEMENT BA-17 INST. SHEET BA-117-11 STC: SA71GL	II	7 ^{7/8}	6 ^{3/4}	1		CESSNA 9910200-1 P12-6138	CESSNA: 310R
BA-118 ELEMENT BA-18 INST. SHEET BA-118-03 STC: SA71GL	II	6 ^{3/16} 4.40 I.D.	6 ^{1/4}	7/8		5AWA (R-4197)	BOEING "STEARMAN": A75, N1, B75, D75, E75
BA-120 ELEMENT BA-20 INST. SHEET BA-120-3 STC: SA693CE	II	7 ^{7/8}	2 ^{5/8}	3/4		550015-501 FRAM CA146PL A-134C AC-8994656	GULF STREAM AMERICAN "TIGER" AA5B; ■ "COUGAR" GA-7 ■ = Must Have P/N P225 Metal Frame To Hold Assembly Together

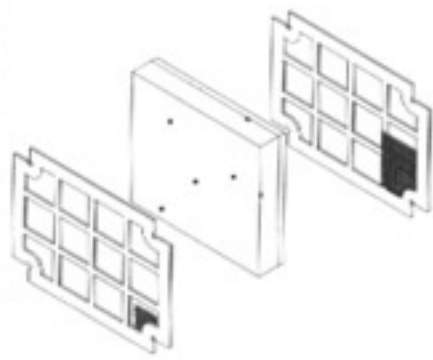
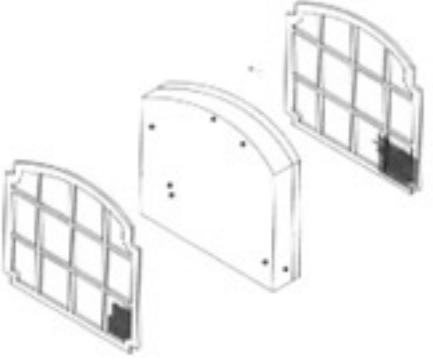

BRACKETT AIR FILTERS

SPECIFICATIONS

ASSEMBLY	STYLE	DIMENSIONS			BASE ATTACHMENT DIMENSIONS	X-REF FILTER PART NO.	ELIGIBLE MODELS
		A	B	C			
BA-121 ELEMENT BA-27 INST. SHEET BA-121-03 STC: SA71GL	II	5 ¹³ / ₁₆	3 ¹² / ₁₆	⁷ / ₈		201-485 HRJ-33-1-2	PIPER "TWIN COMANCHE": PA-30, 39 with RAYJAY TURBOS
BA-130 ELEMENT BA-30 INST. SHEET BA-130-17 STC: SA71GL	II	8 ¹² / ₁₆	6 ⁷ / ₁₆	1		CESSNA 9910141-1 P12-8157	CESSNA "TITAN": 404
BA-151 ELEMENT BA-151E INST. SHEET BA-151-03 STC: SA71GL	K	9 ⁷ / ₈	8 ⁹ / ₁₆	2		ROCKWELL 3610239-1 610239 AM 122623 125087-007	AERO COMMANDER: 500 B, 500A, 560F, 680F, 680FL, 680FLP, 500U NOTE: KIT
BA-152 ELEMENT BA-152E INST. SHEET BA-152-03 STC: SA71GL	K	9 ³ / ₄	8 ¹ / ₈	2		ROCKWELL 3610200 126053-002	AERO COMMANDER: 500 NOTE: KIT
BA-162 ELEMENT BA-162E INST. SHEET BA-162-01 STC: SA71GL	K	6 ¹ / ₂	3 ³ / ₄	³ / ₄		PART 68-7.5057C-13	PARTENAVIA: P68, B, C P68 OBSERVER NOTE: ELEMENT ONLY

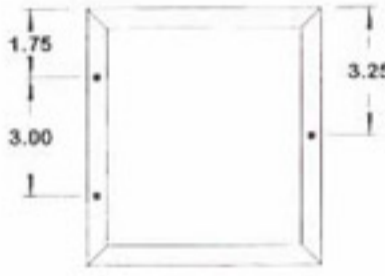

BRACKETT AIR FILTERS

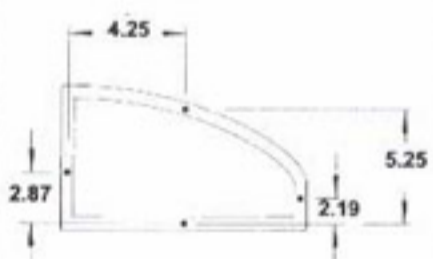
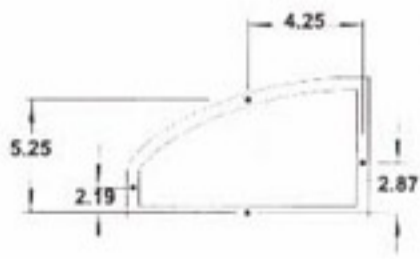
SPECIFICATIONS

ASSEMBLY	STYLE	DIMENSIONS			BASE ATTACHMENT DIMENSIONS	X-REF FILTER PART NO.	ELIGIBLE MODELS
		A	B	C			
BA-183 ELEMENT BA-183E STC: PENDING	I					BEECH 125400-006 50-389070-15 P10-8700	BEECH "DUKE": 60, A60
BA-2010 ELEMENT BA-6108 GRILL BA-6102 GASKET BA-2002 INST. SHEET BA-2004 STC: SA71GL	I	6	6 ^{1/2}	1		P13-3881 P133881	BEECH "SKIPPER": MODEL 77
BA-2110 ELEMENT BA-2305 GRILL BA-2102 GASKET BA-2103 INST. SHEET BA-2104 STC: SA71GL	III	10	4 ^{1/32}	2		CESSNA 0850550-2 MAZE 13778	CESSNA: 205, 205A, (210-5A) CESSNA: 210, A, B, C CESSNA: 310, A, B
BA-2210L ELEMENT BA-2205L GRILL BA-2207L GASKET BA-2206 INST. SHEET BA-2203 STC: SA71GL	III	9	4 ^{1/4}	2		CESSNA 125678L CESSNA 1250704-3 P11-2206 P10-5290	CESSNA: P206, A, B, C, D, E CESSNA: U206, A, B, C, D, E, F, G CESSNA: 207, A CESSNA: 210D, E, F, G, H, J, K*, L*, M, N (TRU S/N 21064535 w/o AIR) NOTE: * = S/N 21059200 thru 21061039 require both LH and RH Filters
BA-2210R ELEMENT BA-2205R GRILL BA-2207R GASKET BA-2206 INST. SHEET BA-2203 STC: SA71GL	III	9	4 ^{1/4}	2		CESSNA 125678R CESSNA 1250704-2 1250704-4 1250704-5 AM10223FP P11-3206	CESSNA: 210K THRU 210L (S/N 59200 THRU 61039)

BRACKETT AIR FILTERS

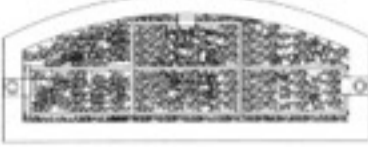
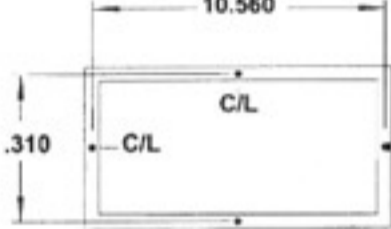
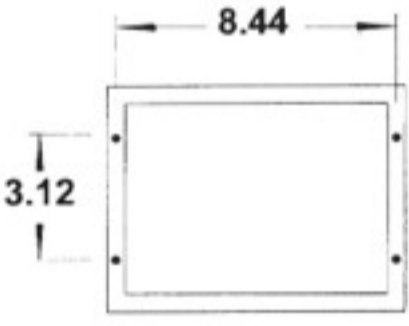
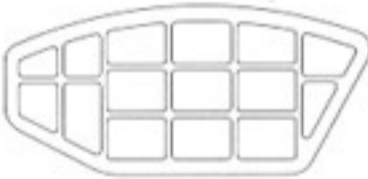
SPECIFICATIONS

ASSEMBLY	STYLE	DIMENSIONS			BASE ATTACHMENT DIMENSIONS	X-REF FILTER PART NO.	ELIGIBLE MODELS
		A	B	C			
BA-2310 ELEMENT BA-2305 GRILL BA-2302 GASKET BA-2303 INST. SHEET BA-2304 STC: SA71GL	III	10	4 ^{1/32}	2		CESSNA 0850550-3 MAZE 122821	CESSNA: 310F, G, H, J, K, L
BA-2410 ELEMENT BA-2405 GRILL BA-2404 INST. SHEET BA-2403 STC: SA71GL	I	11 ^{1/16}	5 ^{13/16}	2		CESSNA 1250846-1 P10-7210	CESSNA: TP206, A, B, C, D, E CESSNA: TU206, A, B, C, D, E, F, G CESSNA: T207, A CESSNA: T-210F, G, H, J, K, L, M, N
BA-2510 ELEMENT BA-2505 GRILL BA-2502 GASKET BA-2503 INST. SHEET BA-2506 STC: SA71GL	I	8 ^{15/16}	6 ^{1/2}	2		C294510-0901 P13-1367	CESSNA: R-182, T182, TR 182 REIMS CESSNA: FR-182
BA-2610L ELEMENT BA-2605L INST. SHEET BA-2610-02 STC: SA71GL	IV	10 ^{13/32}	4 ^{25/32}	2		A-126053-001 3610089-1 610089-1 120278	AERO/GULFSTREAM/TWIN COMMANDER: 560, 560A, 560E, 680 NOTE: No Gasket, Slide-In Type
BA-2610R ELEMENT BA-2605R INST. SHEET BA-2610-02 STC: SA71GL	IV	10 ^{13/32}	4 ^{25/32}	2		A-126053, -003 3610089, -2 610089-2 120279	AERO/GULFSTREAM/TWIN COMMANDER: 560, 560A, 560E, 680 NOTE: No Gasket, Slide-In Type

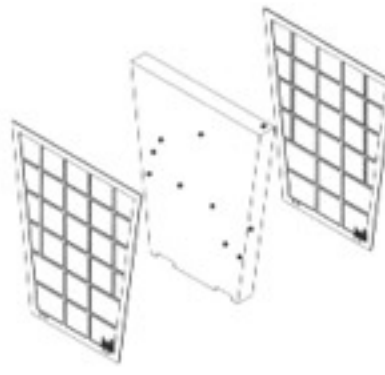
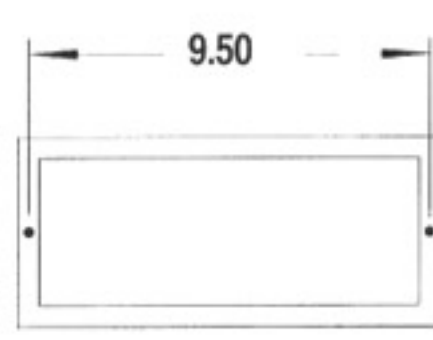
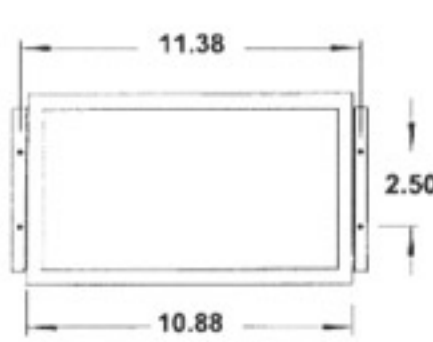
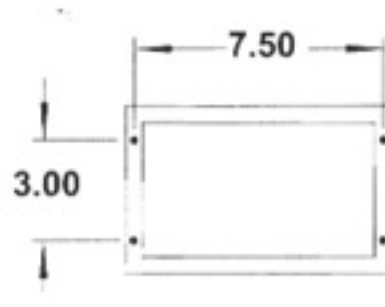
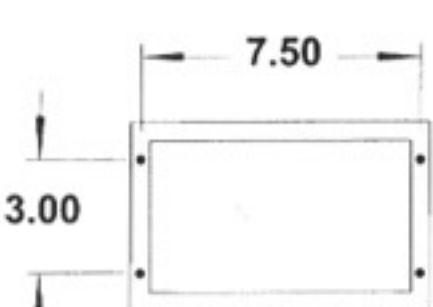

BRACKETT AIR FILTERS

SPECIFICATIONS

ASSEMBLY	STYLE	DIMENSIONS			BASE ATTACHMENT DIMENSIONS	X-REF FILTER PART NO.	ELIGIBLE MODELS
		A	B	C			
BA-2710 ELEMENT BA-2705 INST. SHEET BA-2710-02 STC: SA71GL	IV	9 ^{3/4}	12	3/4		CESSNA A-52294	CESSNA "BOBCAT": T-50, AT-17 UC-78, JRC-1 NOTE: No Gasket, Slide-In Type; Jacobs Engines
BA-2910 ELEMENT BA-2905 GRILL BA-2910-01 GASKET BA-2910-06 INST. SHEET BA-2910-08 STC: SA71GL	I	10	4 ^{1/2}	2		PA-560-904 D-P13-8683	PIPER "DAKOTA": PA-28-236, SN 28-78911283 & UP
BA-3010 ELEMENT BA-7 GRILL BA-1001 GASKET BA-3010-02 INST. SHEET BA-3010-04 STC: SA71GL	I	10 ^{7/8}	6	2		PA-560-947 D-P11-6739	PIPER "SARATOGA": PA-32-301T PA-32R-301T
BA-3110 ELEMENT BA-7305 GRILL BA-3101 GASKET BA-3103 INST. SHEET BA-3106 STC: SA71GL	I	8	5	2		120120	LAKE "BUCCANEER": LA-4, LA4-200 NOTE: Offset Grill for Air Scoop
BA-3110A ELEMENT BA-7305 GRILL BA-3101A INST. SHEET BA-3106A STC: SA71GL	I	8	5	2		120120 17775-00	PIPER "APACHE": PA23-150, -160 PIPER "COMANCHE 180": PA24-180 TO S/N 1476 NOTE: 3110A has no Gasket on Filter and has Air Lock Fasteners

BRACKETT AIR FILTERS

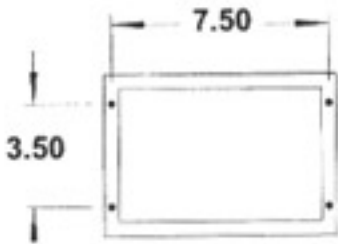
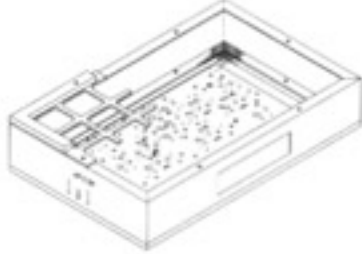
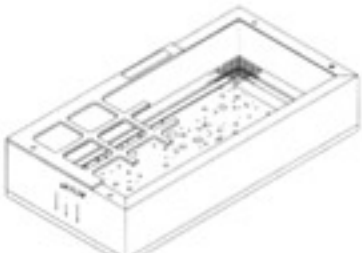
SPECIFICATIONS

ASSEMBLY	STYLE	DIMENSIONS			BASE ATTACHMENT DIMENSIONS	X-REF FILTER PART NO.	ELIGIBLE MODELS
		A	B	C			
BA-3210 ELEMENT BA-3205 GRILL BA-3202 INST. SHEET BA-3204 STC: SA71GL	I	8	6 ^{1/2}	2		PIPER 17775-02 121324	PIPER "COMANCHE": PA24-250 TO S/N 1477
BA-3310 ELEMENT BA-3305 GRILL BA-3310-01 GASKET BA-3310-03 INST. SHEET BA-3310-06 STC: SA71GL	I	11 ^{13/16}	7 ^{9/16}	2		PIPER 460-609 47075-00	PIPER: PA-31P PIPER "MOJAVE": PA-31P-350
BA-3510 ELEMENT BA-3505 GRILL BA-3510-02 GASKET BA-3510-06 INST. SHEET BA-3510-04 STC: SA71GL	I	10 ^{7/8}	5 ^{5/8}	2		PA-460-889 P11-4363 P13-8580 26874-00 P11-4419	PIPER "TURBO AZTEC": PA-23-250, PA-E23-250 with LYCOMING TURBO (ELIGIBLE SN's 27-4426, 27-4574 AND UP) PIPER "TURBO SEMINOLE": PA-44-180T
BA-3810 ELEMENT BA-3805 INST. SHEET BA-3810-04 STC: SA71GL	IV		9 ^{1/4}	2		AM105-389000-3	CESSNA: 411, 411A NOTE: No Gasket, Slide-In Type
BA-3910 ELEMENT BA-3905 INST. SHEET BA-3910-03 STC: SA71GL	IV	8 ^{1/2}	5 ^{5/8}	1		124748-019 AM107499FP-00736	COMMANDER: 100-180, 112, 112A, 112B NOTE: No Gasket, Slide-In Type

BRACKETT AIR FILTERS

SPECIFICATIONS

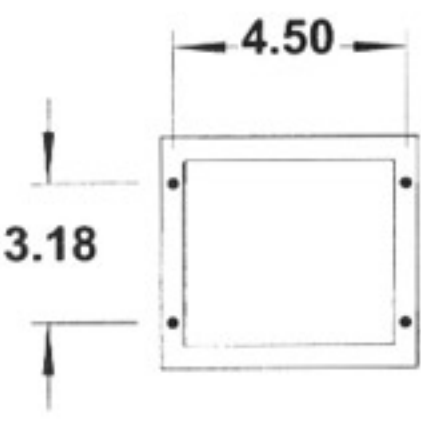
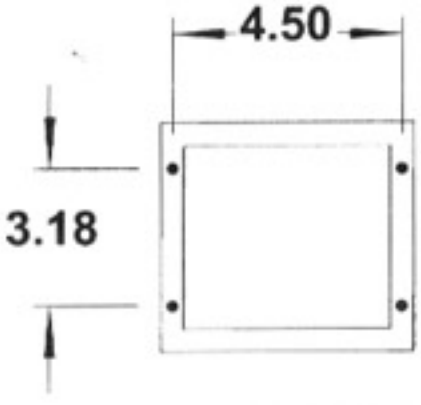
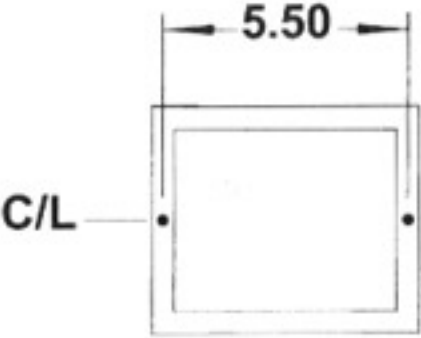
ASSEMBLY	STYLE	DIMENSIONS			BASE ATTACHMENT DIMENSIONS	X-REF FILTER PART NO.	ELIGIBLE MODELS
		A	B	C			
BA-4010 ELEMENT BA-4005 INST. SHEET BA-4010-04 STC: SA71GL	IV	10	7	3/4		124748-036 615045-1 AM107599FP-00736	COMMANDER "GRAN TURISMO": 112TC, 112TC-A, 114, 114A NOTE: No Gasket, Slide-In Type
BA-4106 ELEMENT BA-4108 GRILL BA-4102 GASKET BA-4101 INST. SHEET BA-4105 STC: SA71GL	I	5	5 ^{1/2}	1		P12-0494 C294510-0201 AM 13203 40599 560-722 460-638 P10-7150 AAF-117	AERONCA: 65CA CESSNA: 120, 140, 140A, 150, 150A, 150B, 150C, 150D, 150E, 150F, 150G, 150H, 150J, 150K, 150L, 150M, A150M, 152, A152 CHAMPION: 7ECA w/CONTINENTAL 0-200-A, 7ACA, 7ECA, 7FC LUSCOMBE: 8, 8A, 8B, 8C, 8D, 8E, 8F, T-8F MOONEY: M10 MORRISEY: 2150A PIPER: J3, J3C-65, J3C-65S, J4A, J4AS, J4E, J5A, J5A-80, PA-11, PA-11S, PA-12, PA-12S, PA-16, PA-17, PA-18, PA-18A, PA-18S, PA-18-125 (ARMY L-21), -18AS-"125", -18-"135" (ARMY L-21B), 18A-"135", -18AS-"135", -18S-"135", 18-"150", 18A-"150" (SN 18-1 TO -6963), PA-19, PA-20-115, -135, PA-22, -108, -135, -150, -160, PA-38-112 REIMS (CESSNA): F150G, H, J, K, L, M; FA150K, L, F152, FA152 SHINN: 2150A TAYLORCRAFT: BC65, BCS-65, BC12-65, BCS12-D1, BCS12-65, BC12-D, BC12D85, BCS12D-85, BC12D-4-85, BCS12D-4-85, 19, F19, F21, DC-65, DC0-65 UNIVAR "ERCOUPE"(ALON): A-2, A-2A (FORNEY): F-1, F-1A UNIVERSAL "SWIFT": GC-1A, GC-1B VARGA "KACHINA": 2150A
BA-4210 ELEMENT BA-4108 GRILL BA-4202 GASKET BA-4201 INST. SHEET BA-4205 STC: SA71GL	I	5	5 ^{1/2}	1		AM 13202	GULFSTREAM AMERICAN "YANKEE": AA-1, AA-1A, AA-1B, AA-1C, AA-5
BA-4310 ELEMENT BA-4305 GRILL BA-4302 GASKET BA-4303 INST. SHEET BA-4306 STC: SA71GL	I	6	5	2		AM 123664	NAVION B "RANGE MASTER": G, H OR WITH IO-470

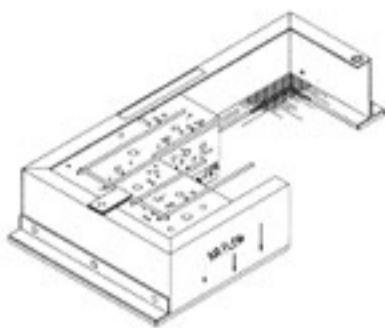
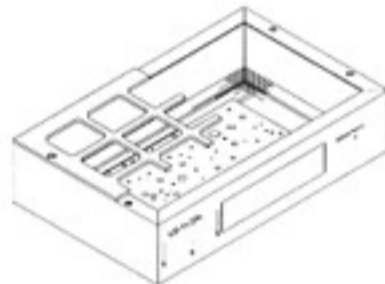
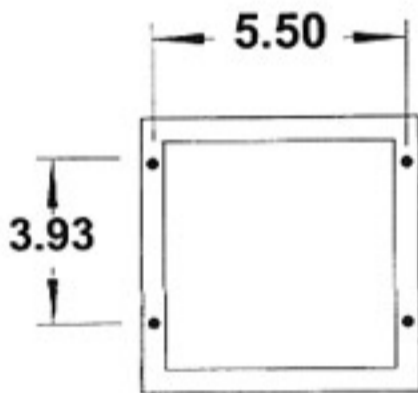
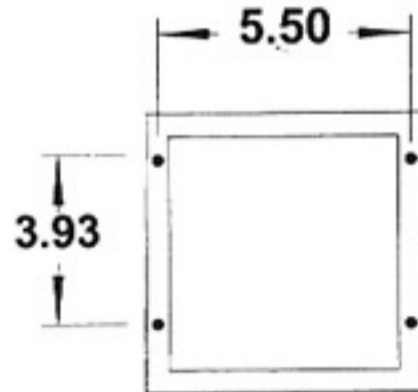

BRACKETT AIR FILTERS

SPECIFICATIONS

ASSEMBLY	STYLE	DIMENSIONS			BASE ATTACHMENT DIMENSIONS	X-REF FILTER PART NO.	ELIGIBLE MODELS
		A	B	C			
BA-4510 ELEMENT BA-4505 GRILL BA-4506 GASKET BA-4502 INST. SHEET BA-4507 STC: SA71GL	I	10	5 ^{1/2}	2		26874-00 P11-4419	PIPER "COMANCHE": PA24-260C SN24-4783, SN24-4804 AND UP
BA-4810 ELEMENT BA-4805 GRILL BA-4803 INST. SHEET BA-4804 STC: SA71GL	IV	10	6 ^{1/2}	2		A-13821	BEECH "TWIN BONANZA": 50, B50, C50, D50, D50A, D50B, D50C, D50E NOTE: No Gasket, Slide-In Type
BA-5110 ELEMENT BA-6108 GRILL BA-5102 GASKET BA-5103 INST. SHEET BA-5105 STC: SA71GL	I	6 ^{1/4}	6 ^{1/2}	1		C294510-0301 AM 13219 TCM 40689 P10-7172 AAF-118	CESSNA: 170 ALL 172 THRU M MOONEY "MITE": M-18C REIMS (CESSNA): F172D, E, F, G, H, K, L, M
BA-5110A ELEMENT BA-6108 GRILL BA-5102 GASKET BA-5103 INST. SHEET BA-5111 STC: SA71GL	I	6	6 ^{1/2}	1		C294510-0301 P10-7172	CESSNA: 172N, P REIMS (CESSNA): F172N, P NOTE: Same as BA-5110 except Airloc Fasteners for Cowl Removal

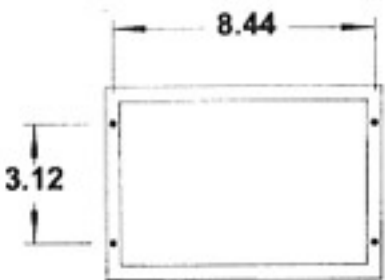

BRACKETT AIR FILTERS

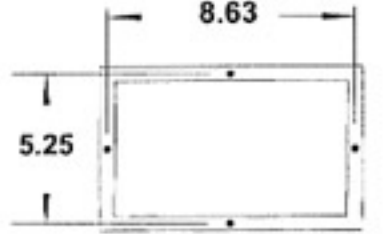
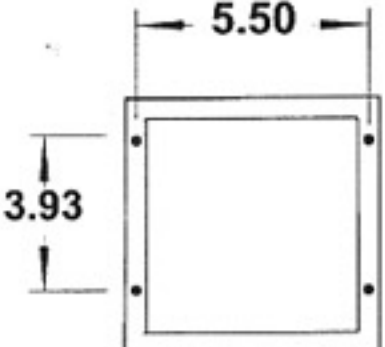
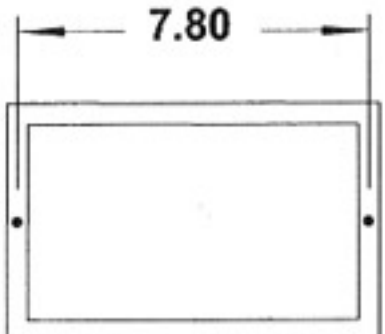
SPECIFICATIONS

ASSEMBLY	STYLE	DIMENSIONS			BASE ATTACHMENT DIMENSIONS	X-REF FILTER PART NO.	ELIGIBLE MODELS
		A	B	C			
BA-5210 ELEMENT BA-5205 GRILL BA-5202 GASKET BA-2503 INST. SHEET BA-5203 STC: SA71GL	I	8 ^{15/16}	6 ^{1/2}	2		C294510-0902 P14-8670	CESSNA "CRUSADER": T303
BA-5710 ELEMENT BA-5705 GRILL BA-5702 GASKET BA-5703 INST. SHEET BA-5704 STC: SA71GL	I	7 ^{3/4}	6 ^{15/16}	1		C294510-0601 P11-0172 6163001-0901 AM107635FB	CESSNA "CARDINAL": 177, 177A, B RG, RG II, F177RG
BA-5810 ELEMENT BA-5805 GRILL BA-5804 GASKET BA-5803 INST. SHEET BA-5806 STC: SA71GL	I	9	5 ^{5/8}	2		C294510-0501 P10-8337 AM 10-2035FP	CESSNA "TURBO SKYMASTER": T337B THRU H, T337H-5P (REAR ENGINE ONLY) CESSNA: 172 RG
BA-6110 ELEMENT BA-6108 GRILL BA-6102 GASKET BA-5103 INST. SHEET BA-6105 STC: SA71GL	I	6	6 ^{1/2}	1		AM 13219 102465FP P12-6491	MOONEY: M20, M20A, B, C, D, G MAULE: M-4, M-4C, M-4S, M-4T, M-4-220, M-4-220C, M-4-220S, M-4-220T, M-4-180C, M-4-180S, M-4-180T, M-5-220C, M-5-235C, M-5-180C, M-5-210TC, M-6-180, M-6-235, M-7-235, MX-7-180
BA-6210 ELEMENT BA-6205 GRILL BA-6202 INST. SHEET BA-6206 GASKET 6203 STC: SA71GL	I	8 ^{23/64}	5	2		P13-0234	MOONEY "201": M20J

BRACKETT AIR FILTERS

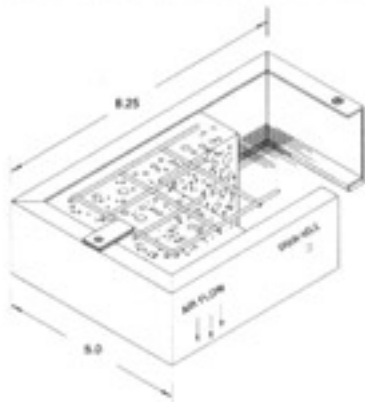
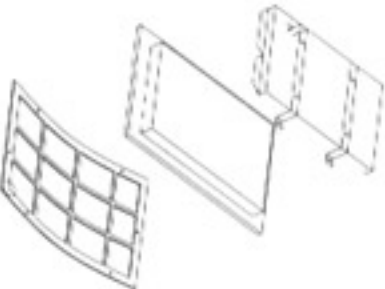
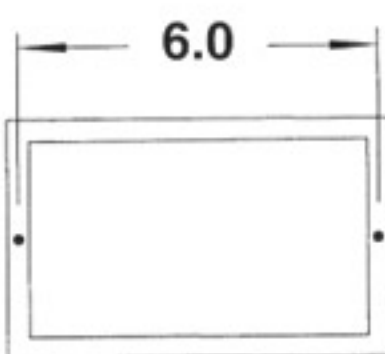
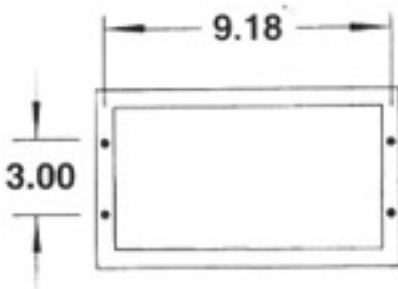
SPECIFICATIONS

ASSEMBLY	STYLE	DIMENSIONS			BASE ATTACHMENT DIMENSIONS	X-REF FILTER PART NO.	ELIGIBLE MODELS
		A	B	C			
BA-6210-1 ELEMENT BA-6205 GRILL BA-7501 INST. SHEET BA-6206-1 STC: SA71GL	I	8 ^{1/4}	5	2		121128-2 P12-7996	BEECH "BARON": C-55, D-55, E-55, E55A, (S.N. 468-1078), 58 (S.N. TH1 THRU TH740) NOTE: No Gasket, Clip In Type
BA-6310 ELEMENT BA-6305 GRILL BA-6302 INST. SHEET BA-6304 STC: SA71GL		6 ^{3/4}	10 ^{1/2}	1	 <p style="text-align: center;">CURVED FRONT</p>	P-10-4065 P11-3576	MOONEY "SUPER 21": M20E, F NOTE: Grill & Basket Type
BA-7010 ELEMENT BA-7005 GRILL BA-7010-02 GASKET BA-7010-03 INST. SHEET BA-7010-04 STC: SA71GL	I	6 ^{1/2}	5 ^{7/8}	2		105-389000-3 P13-6680	BEECH "DUCHESS": 76
BA-7110 ELEMENT BA-7112 GRILL BA-7101 GASKET BA-7104 INST. SHEET BA-7108 STC: SA71GL	I	9 ^{3/4}	5	2		AM 13917 P13-0374 45-921210	BEECH: "DEBONAIR": 33 ALL 225 H.P. BONANZA: B35 S/N D2606 AND UP C-35, D-35, E-35, F-35, G-35, H-35, J-35, K-35, M-35, N-35, P-35, E33, F-33
BA-7210 ELEMENT BA-7112 GRILL BA-7201 GASKET BA-7206 INST. SHEET BA-7205 STC: SA71GL	I	10	5	2		35-380035-1, -5, -7 AM 122043-1 P10-5304 P13-7627	BEECH "BONANZA": S35 AFTER S/N D-7672 V35, V35A, V35B, 36, A36, A36TC, B36TC E33A, E33C, F33A, F33C, G33 BEECH "MENTOR": T-34 w/STC SA-1450SW CONT IO-520 NOTE: 2 Stud Hold Down

BRACKETT AIR FILTERS

SPECIFICATIONS

ASSEMBLY	STYLE	DIMENSIONS			BASE ATTACHMENT DIMENSIONS	X-REF FILTER PART NO.	ELIGIBLE MODELS
		A	B	C			
BA-7310 ELEMENT BA-7305 GRILL BA-7301 GASKET BA-7303 INST. SHEET BA-7306 STC: SA71GL	I	7 ^{3/4}	5	2		35-921210 P13-0375 120737	BEECH "BONANZA": 35, A35, B35 (UP TO S/N D2605)
BA-7410 ELEMENT BA-7112 GRILL BA-7201 GASKET BA-7406 INST. SHEET BA-7405 STC: SA71GL	I	10	5	2		35-380035 35-380035-3 AM 122943-1 P10-2646	BEECH "BONANZA": S-35 S/N D-7310 THRU D-7626 NOTE: 4 Stud Hold Down
BA-7510 ELEMENT BA-7305 GRILL BA-7501 GASKET BA-7504 INST. SHEET BA-7503 STC: SA71GL	I	8 ^{1/4}	5	2		169-380064-1, -3 P12-2322	BEECH: "SIERRA" & "SUNDOWNER": C-23, A24R, B24R, C24R, B19
BA-7610 ELEMENT BA-7605 GRILL BA-7602 GASKET BA-7603 INST. SHEET BA-7604 STC: SA71GL	IV	10 ^{7/16}	4	2		MAZE 122601 P12-8219	BEECH "BARON": 55, A55, B55 NOTE: Gasket Around Periphery, Slide-In Style
BA-7710 ELEMENT BA-7705 GRILL BA-7701 GASKET BA-7703 INST. SHEET BA-7704 STC: SA71GL	I	8 ^{5/16}	6 ^{1/8}	2		96-389005-1 P12-8167	BEECH "BARON": E55, E55A (S/N TE-1079 AND UP), 58, 58A, TH741 & UP

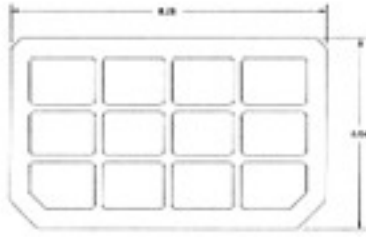
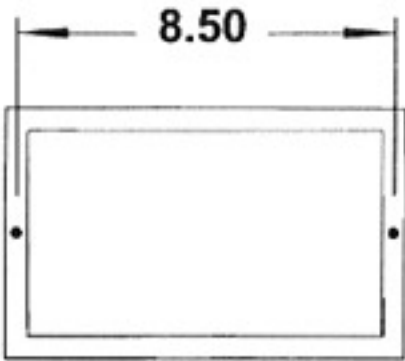
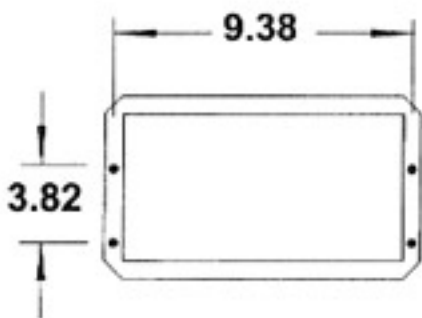
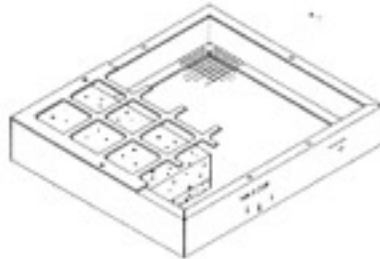
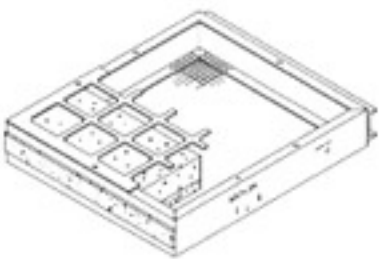

BRACKETT AIR FILTERS

SPECIFICATIONS

ASSEMBLY	STYLE	DIMENSIONS			BASE ATTACHMENT DIMENSIONS	X-REF FILTER PART NO.	ELIGIBLE MODELS
		A	B	C			
BA-7810 ELEMENT BA-7805 INST. SHEET BA-7810-02 STC: SA71GL	IV	8 ¹⁴	4 ^{15/16}	2		A-121128-1	BEECHCRAFT "TRAVELAIR": 95, B95, B95A, D95A NOTE: No Gasket, Slide-In Type
BA-8010 ELEMENT BA-8005 GRILL BA-8001 GASKET BA-8002 INST. SHEET BA-8004 STC: SA71GL	I	9	7 ^{1/8}	1		0750114 AM 13814 TYPE P1A	CESSNA: 180 (1953-55)
BA-8110 ELEMENT BA-8103-1 GRILL BA-8102 GASKET BA-8101 INST. SHEET BA-8105 STC: SA71GL	I	9 ^{7/8}	6 ^{1/2}	2		0750038-1, -4 0750146-1 P10-4145 P10-6150 0750127-12, -14 AM104935FP	BELLANCA: 14-19-3A, 17-30 CESSNA: 180A Thru K CESSNA: 182 Thru R CESSNA: 185 Thru E; A185E, F REIMS (CESSNA): F182P, F182Q CHAMPION: 7GCAA, 7GCBC, 8GCBC, 7KCAB, 8KCAB
BA-8210 ELEMENT BA-8205 GRILL BA-8206 INST. SHEET BA-8203 STC: SA71GL	IV	11 ^{13/32}	10	2		A 1693-1 125435	GRUMMAN "AG CAT": G-164, G-164A, G-164B TO S/N 1-176 NOTE: No Gasket, Slide-In Type
BA-8210-1 ELEMENT BA-8205 GRILL BA-8206 GASKET BA-8208 INST. SHEET BA-8203-1 STC: SA71GL	I	11 ^{13/32}	10	2		053422188-3	DE HAVILLAND "BEAVER": DHC-2, MK-1, M-II, M-III (L-20) NOTE: Slide-In Type, End Gasket

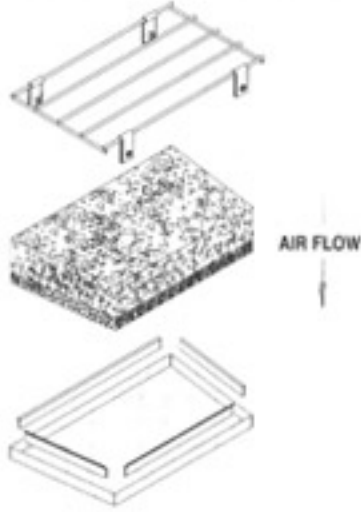
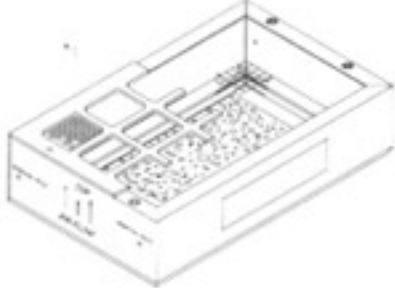
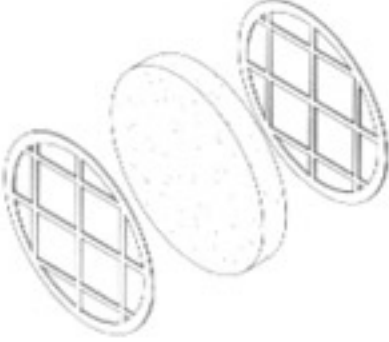

BRACKETT AIR FILTERS

SPECIFICATIONS

ASSEMBLY	STYLE	DIMENSIONS			BASE ATTACHMENT DIMENSIONS	X-REF FILTER PART NO.	ELIGIBLE MODELS
		A	B	C			
BA-8310 ELEMENT BA-8305 GRILL BA-8302 INST. SHEET BA-8304 STC: SA71GL	I	27	8 ^{1/2}	1		88-42098 55-42088	NORTH AMERICAN: T-6 ALL & SNJ HARVARD NOTE: No Gasket, Slide-In Type
BA-8410 ELEMENT BA-8405 INST. SHEET BA-8406 STC: SA71GL	IV	10 ^{1/4}	6 ^{3/4}	2		56-1456	CESSNA: 190, 195, A, B NOTE: No Gasket, Slide-In Type
BA-8610 ELEMENT BA-8605 GRILL BA-8606 SCREEN BA-8601 INST. SHEET BA-8607 STC: SA71GL	K	8	4 ^{5/8}	2		GARRETT-DURALIFE 096SCD018 P10-6390	PIPER "AZTEC TURBO": PA-23-250, PA23E-250 SN 27-2505 THRU 27-7554168 with AIRESEARCH TURBO NOTE: Kit Type
BA-8710 ELEMENT BA-8705 GRILL BA-8710-02 GASKET BA-8710-04 INST. SHEET BA-8710-03 STC: SA71GL	I	10	6 ^{3/8}	2		C294510-0801	CESSNA: P-210N, R
BA-8810 ELEMENT BA-8805 INST. SHEET BA-8810-03 STC: SA71GL	IV		5			415-40585-1	ERCO: 415C, 415CD, 415D, E, G NOTE: Clip In Flat Panel Type

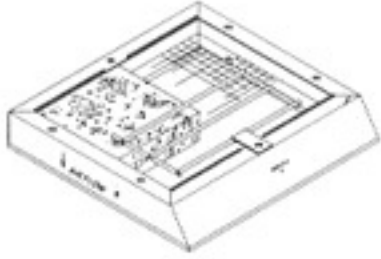

BRACKETT AIR FILTERS

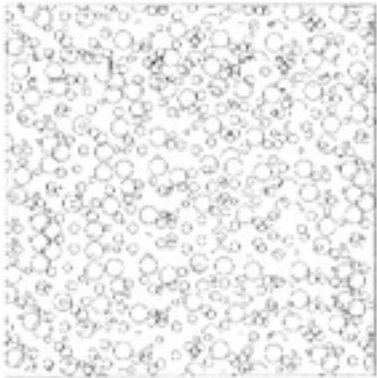
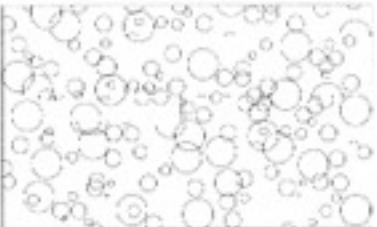
SPECIFICATIONS

ASSEMBLY	STYLE	DIMENSIONS			BASE ATTACHMENT DIMENSIONS	X-REF FILTER PART NO.	ELIGIBLE MODELS
		A	B	C			
BA-8910 ELEMENT BA-8905 GRILL BA-8910-04 GASKET BA-8910-02 INST. SHEET BA-8910-03 STC: SA71GL	I	7	6	1		124748-019 121262-7	AERO COMMANDER "DARTER": 100, 100A
BA-S108K (BA-9110) ELEMENT S108K-05 (BA-9105) INST. SHEET BA-9110-03 STC: SA71GL	K	8 ^{1/2}	5 ^{1/4}	1		108-6221805 13197	STINSON "VOYAGER": 108, 108-1, 108-2, 108-3 NOTE: Kit Type
NO FRAME REQUIRED ELEMENT BA-4 STC: SA693CE		13 ^{1/2}	4 ^{1/2}	1		560-935 310008-1 AC-A6485463	PIPER "AEROSTAR": 600, 601, 602
NO FRAME REQUIRED ELEMENT BA-16 STC: SA693CE		5 ^{15/16}	5 ^{15/16}	1		560-679 35468-00	PIPER "WARRIOR": PA-28-151, -161
NO FRAME REQUIRED ELEMENT BA-19 STC: SA693CE		6 ^{1/4}	3 ^{3/4}	2		ORIGINAL AC-8994914	GULF STREAM "CHEETAH": AA5A

BRACKETT AIR FILTERS

SPECIFICATIONS

ASSEMBLY	STYLE	DIMENSIONS			BASE ATTACHMENT DIMENSIONS	X-REF FILTER PART NO.	ELIGIBLE MODELS
		A	B	C			
NO FRAME REQUIRED ELEMENT BA-21 STC: SA693CE		17 ³⁸	5 ¹²	2		ORIGINAL AC-8995460	HELIO: H295
BA-249 ELEMENT BA-249E IVST. SHEET BA-249 STC: PEND	II	5 ¹³	3 ¹²	3 ⁴		201-485	BELLANCA: 17-31, 17-31A, 17-31 ATC "VIKING" "TURBO VIKING" NOTE: Lycoming Powered
BA-9210 ELEMENT BA-9205 GRILL INST. SHEET STC: PEND	IV					P197268	CESSNA: T206H "TURBO STATIONAIR"