

*Brook*

# STANDARD DUTY

*Generator  
Regulators*



DELCO-REMY DIVISION, GENERAL MOTORS CORPORATION • ANDERSON, INDIANA



Instituted in 1947, the Delco-Remy Service School makes available factory training in the operation, repair and maintenance of Delco-Remy equipment. Representatives of United Motors, UMS Distributors, fleet operators and personnel from the service departments of Delco-Remy customers make constant use of these facilities.





# DELCO-REMY Generator Regulators



Delco-Remy generator regulators are grouped into two general classifications called standard duty and heavy duty. Actually, some standard duty types may be used for heavy duty service. The real difference between the

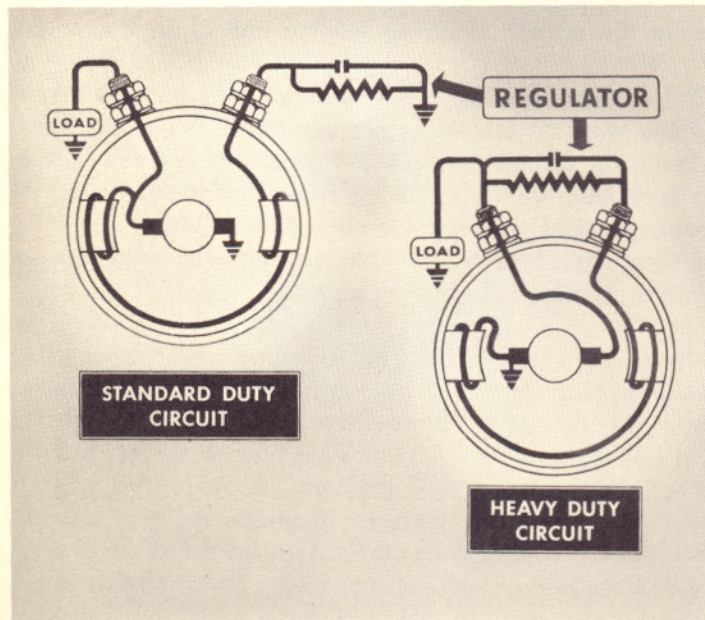

two types is in the method of connecting the regulator into the field circuit. In the standard duty type generator regulators, the generator field circuit is traced from the insulated brush through the field coils, then through the regulator and grounded at the regulator base. In the heavy duty type generator regulators, the generator field circuit is traced from the insulated brush through the regulator, then through the generator field coils and grounded inside the generator.

With few exceptions, all standard duty regulators are of one size and design. Heavy duty regulators have many different designs and vary in size with the number of units required. This discussion will be limited to the standard duty type of circuit and construction.

The basic function of a generator regulator is not generally understood by car operators or service men. Its operation is comparatively simple as it has only one job to do. Regardless of the manufacturer or type of circuit, or whether third brush, two stage, vibrating points, or carbon pile type of control is being used, the regulation

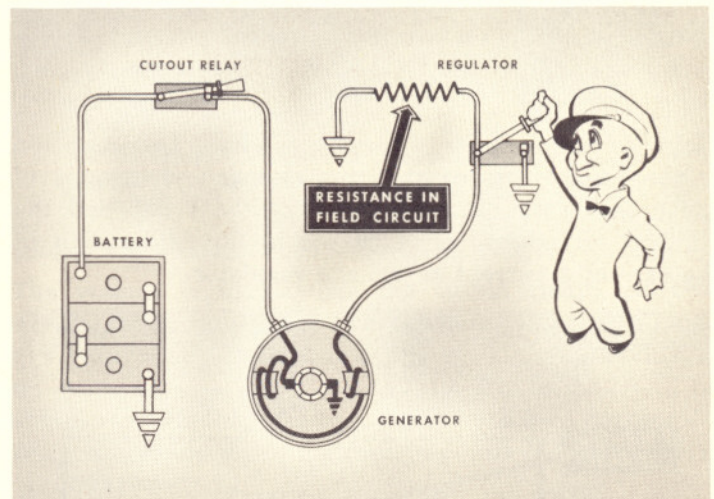

of generator voltage or current output is accomplished only by varying the strength of the generator magnetic field. Putting the required resistance in series with the field circuit at the right time is all that is needed to obtain satisfactory regulation. There are, of course, refinements in methods of changing the effective field resistance, which determine the excellence of the final results.

By looking at a circuit diagram of a regulator, it will be found that there are three distinct paths for current flow. Starting with the generator armature, the charging circuit carries the generator output to the battery when the relay points are closed, and from the battery ground back to the ground of the generator. The field circuit of the standard duty regulator starts at the armature, goes through the generator field coils, through the regulator points to ground, and returns to the generator ground completing the field circuit. Operating circuits consist of voltage windings connected directly across the generator armature and impressed with generator voltage at all times, or series windings which are current sensitive and used for current control. The function of an operating circuit is to attract a hinged armature when the magnetic strength of the core is great enough to overcome



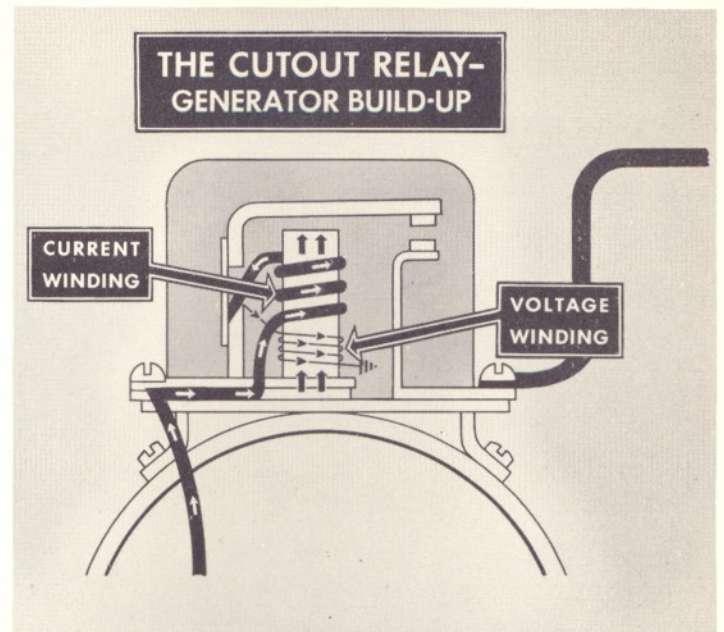
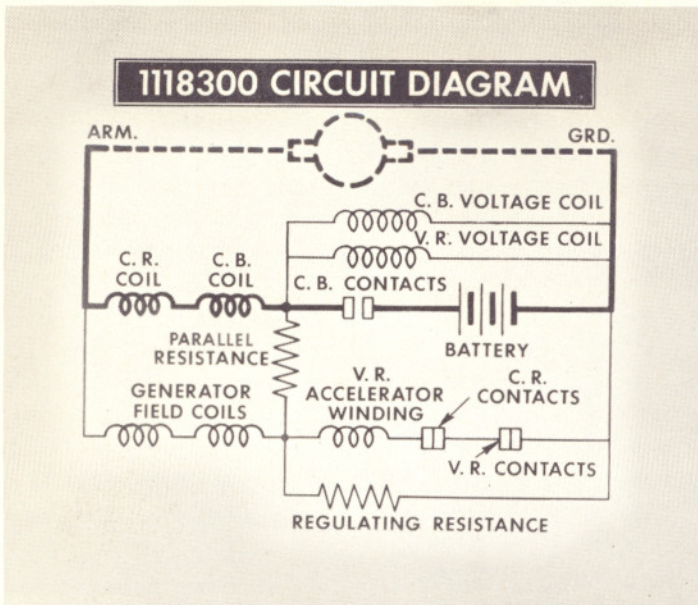

spring tension holding the armature away. The operation of these armatures controls the closing and opening of the charging circuit in the case of the relay, and the addition or removal of resistance in the field circuit in the case of a current or voltage regulator.

In all automotive type D.C. generator circuits, a cutout relay is used. Its points are open when the generator is **not operating**, thus preventing the battery from discharging through the generator. When the generator begins to operate, voltage builds up in the two relay windings, the current winding and the voltage winding, and this creates two magnetic fields which, working together, overcome the armature spring tension and close the points.

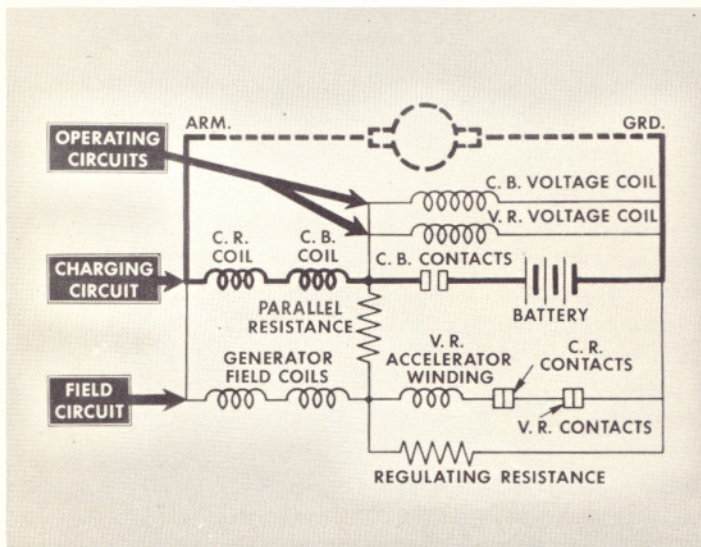

The voltage winding is the working coil and does most of the work in attracting the armature. With the points closed, the circuit between the generator and the battery is complete. Current flowing from the generator to the battery passes through the current winding of the relay in the right direction to add to the magnetism holding the points closed.

The importance of understanding these three circuits cannot be stressed too strongly. All trouble shooting depends upon knowing where to look when certain conditions are indicated. It is also necessary to trace all circuits in one way regardless of system polarity or battery ground. Always start with the source of supply (in this case the generator armature) and trace through to the other side of the circuit, which in most cases is the ground, but which may be a common wire return as used on insulated systems. Tracing circuits in this manner will always insure that the aiding and opposing effects of the various windings, to attract or release a movable armature, will be correctly determined.

When the generator slows or stops, and the battery voltage is higher than the generator voltage, current flows from the battery to the generator. It flows through the voltage winding in the same direction as before, but the direction of current flow through the current winding is reversed, and this causes the magnetic fields of the two windings to oppose each other. As a result, the total magnetic field is no longer strong enough to hold the armature down and the spring tension pulls the armature away from the winding core and the points open, breaking the circuit between the battery and the generator.

For some years the low output, third brush generator provided ample current to meet all requirements. But as heaters, defrosters, radios and other electrical accessories were added to the passenger car, additional generator output became necessary. Generator output was increased to handle the higher current demands.



# DELCO-REMY GENERATOR REGULATORS

With increased generator output, it was necessary to provide additional control or regulation of the generator in order to protect the car battery and electrical system. A high charging rate to a charged battery was normal operation on a straight third brush type of generator and this caused the battery to gas and overheat.

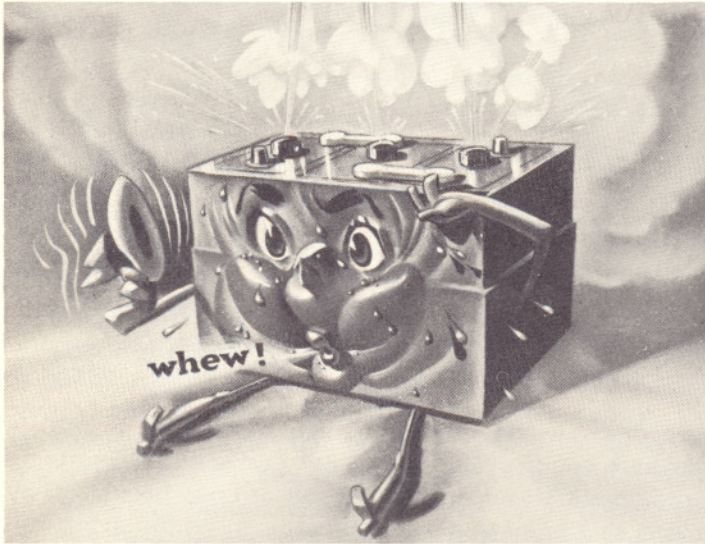

conditions the battery required frequent additions of water to maintain the electrolyte level, and battery life was shortened.

In addition, overcharging tends to force the voltage to an excessively high value, so that high voltage is produced in the electrical system. High voltage burns out light bulbs and radio tubes, and shortens the life of the ignition coil, distributor contact points and other electrical units.

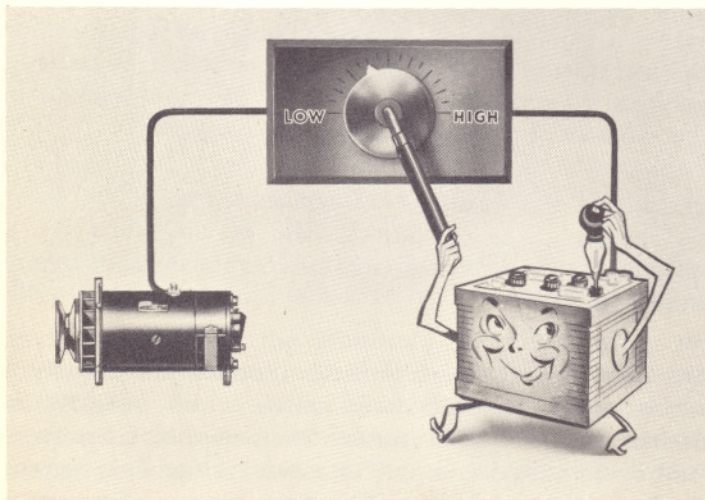

To avoid high voltage and excessive current, the voltage of the charging circuit must be limited as the battery approaches charge. The battery will actually regulate its own charge, within certain temperature limitations, if the voltage in the circuit is kept at a constant value. This

is due to the fact that the opposing or "counter" voltage of the battery increases as the battery comes up to charge. A constant system voltage becomes less and less able to overcome the growing opposition and to force a charging current into the battery. To keep the voltage of the circuit at a constant value, another magnetic switch, the Voltage Regulator, was introduced.

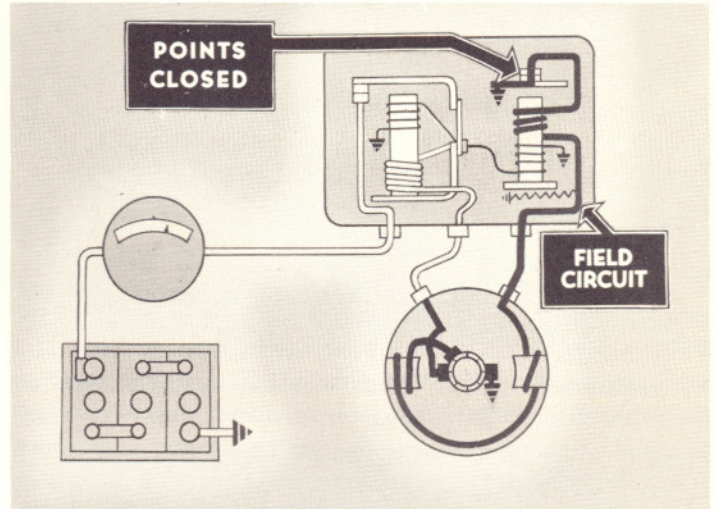

The voltage regulator, like the cutout relay, has two windings. The voltage, or shunt, winding carries full system voltage at all times. It is the working coil and does the work of attracting the armature. The field current or accelerator winding carries the generator field current directly to ground when the contact points of the regulator

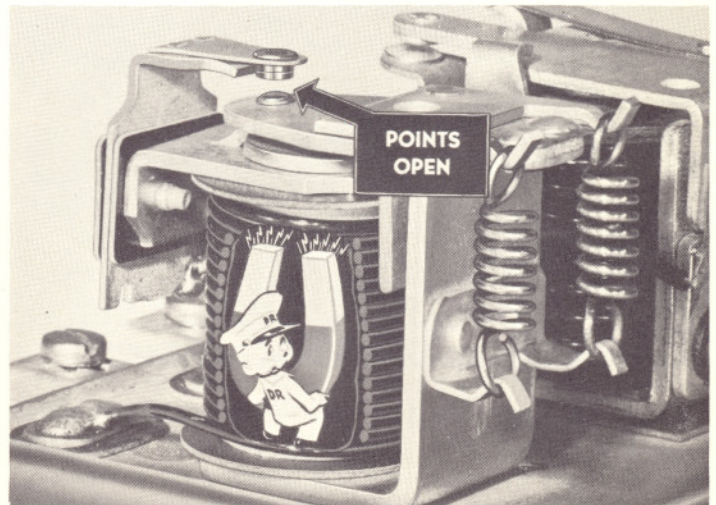

are held closed by spring tension. As the battery approaches a charged condition the system voltage increases, and the two windings build up sufficient magnetic strength to overcome the spring tension and separate the points. When the points open, the generator field current must flow through a resistance to ground, and this causes the generator output to drop off. The instant the points open, current stops flowing through the field current winding



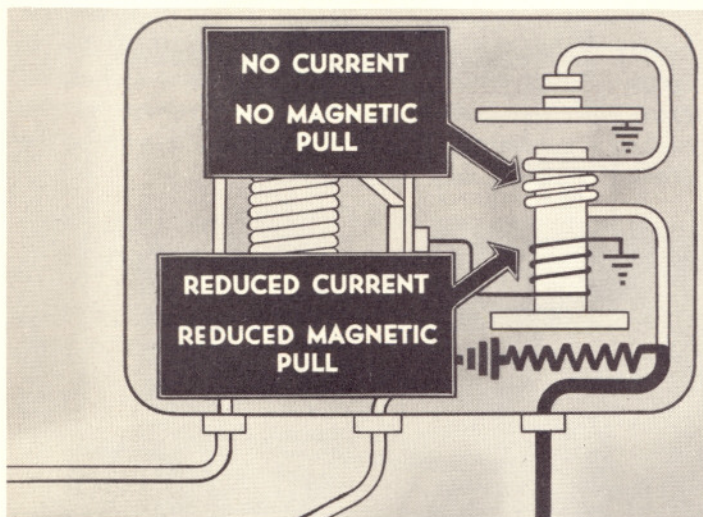

of the regulator and its magnetic field collapses. This, and the weakening of the voltage winding magnetic field as the generator output drops off, reduces the total magnetic field to a point where the spring tension once more causes the contact points to come together. The generator field circuit is thus again grounded directly, and the output increases. This cycle is repeated from 50 to 200 times

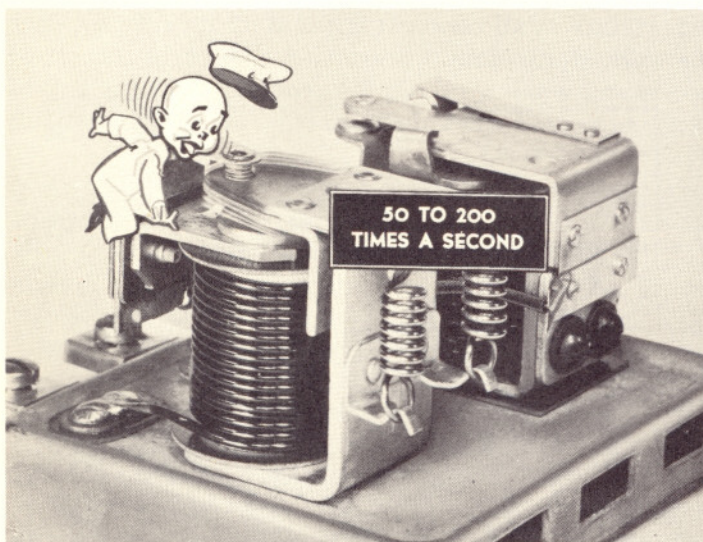

a second, causing a vibrating action of the armature which holds the voltage to a practically constant value. Any winding other than the working winding on a regulator core is used for the purpose of speeding up the rate of armature vibration, thereby reducing the amount of surge when the armature points close.

All operating windings of the regulator, being wound with copper wire, increase in resistance as they become hot. To obtain the same ampere turns to pull the arma-

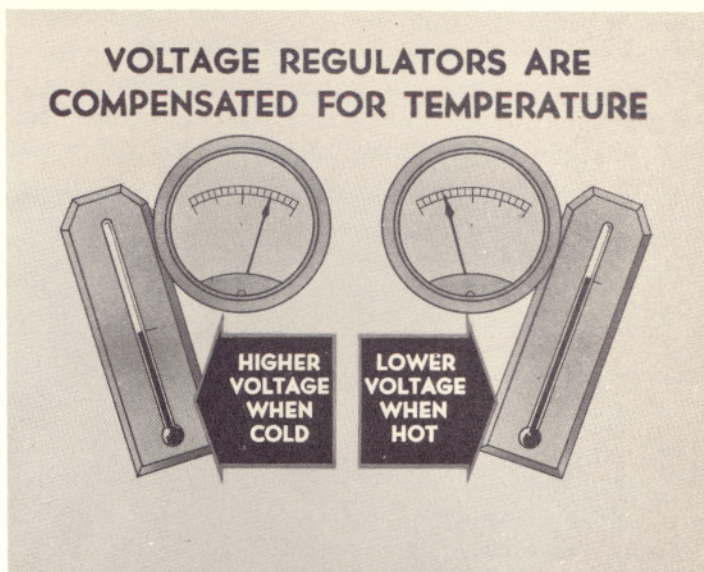

ture down would require a high voltage on a voltage sensitive winding and this is not desirable. Delco-Remy regulators are compensated for this temperature effect by means of a bi-metal thermostatic hinge on the armature.

The bi-metal hinge appears to be made of a thin sheet of spring steel; actually it is made of two thin layers of different metals fused together. These metals are different in that one has little expansion, the other has a large expansion due to heat. The thermostatic action takes place then as the hinge becomes hot, one side expands more than the other causing it to bend.

This type hinge applied to the regulator armature tries to bend as the temperature goes up and reduces the spring tension. Spring tension change compensates for the increased resistance of the copper windings as temperature goes up and the regulator will now operate at the same or slightly lower voltage.

The output of a shunt generator does not have the "taper off" at high speeds characteristic of the third brush generator, so some other form of current limiting device is necessary.

The unit adopted to perform this function is the current regulator, another magnetic switch which operates in the charging circuit to protect the generator from overload by limiting its output to a safe value. The current regulator is mounted on the same base as the cutout relay and the voltage regulator, and all are enclosed by the same cover.



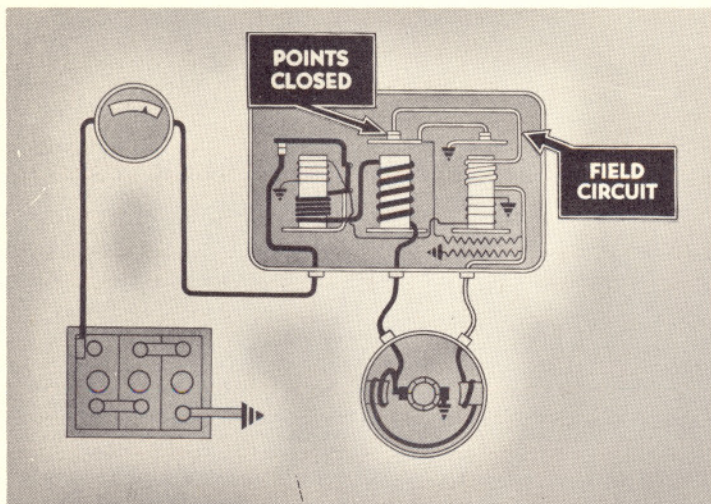

The single winding of the current regulator is composed of heavy wire because it carries all of the generator output. The contact points of the current regulator directly ground the generator field when they are closed. The spring tension holds the points closed so long as the generator output is less than the regulator setting. When the generator output increases to that value, the current flowing through the regulator winding creates sufficient magnetic strength to overcome the spring tension and separate the points. The generator field current must

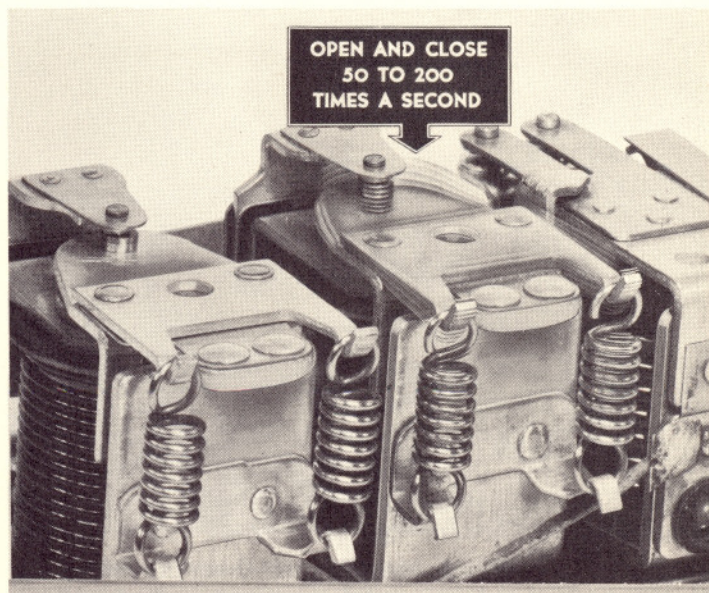

out temperature compensation, whether the regulator is hot or cold.

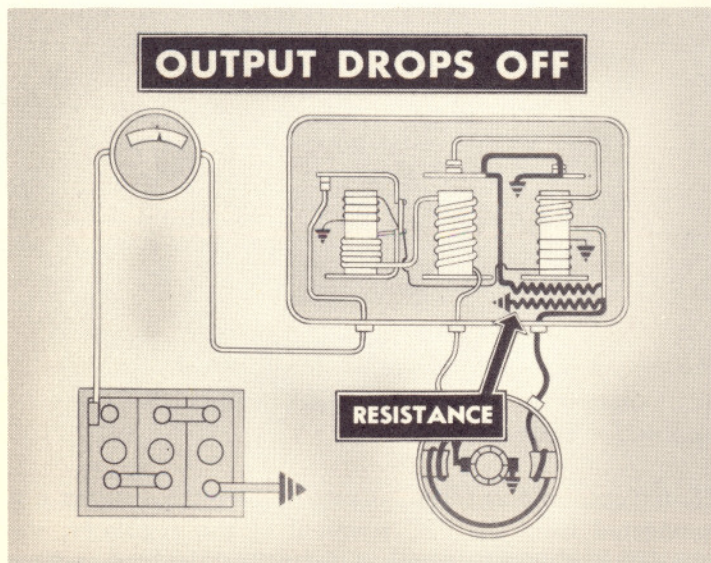

then flow through the resistance, and this causes the generator output to drop off. But as soon as the output drops below the value for which the regulator is set, the magnetic field is so weakened that the points close, and the output once again increases. This cycle takes place 50 to 200 times a second, producing a vibrating action of the armature, which prevents the maximum generator output from exceeding a safe value when properly adjusted. The winding of the current regulator being in series with the charging circuit is sensitive to current only, and the armature is pulled down at the same current value, with-

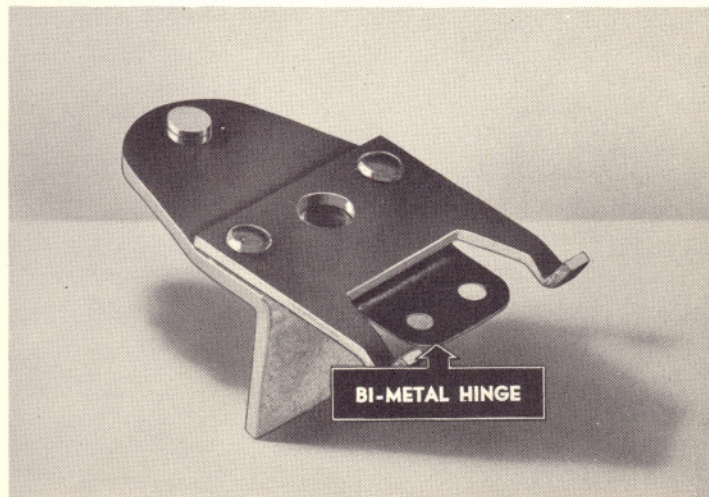

Many current regulators, however, have a bi-metal hinge on the armature for thermostatic temperature control. This permits a somewhat higher generator output when the unit is cold, and causes the output to drop off to a safe maximum as the temperature increases. This is an advantage on short drives where a higher charge rate is obtained for short intervals of time, or until the regulator warms up.

Either the current or the voltage regulator of the three unit generator regulator operates at any one time, both never operate at the same time. When the current requirements of the electrical system are large and the battery is low, the current regulator operates to protect the generator from overload. When the current requirements are small and the battery comes up to charge, the battery counter voltage increases causing the voltage regulator to operate and hold the voltage constant. This



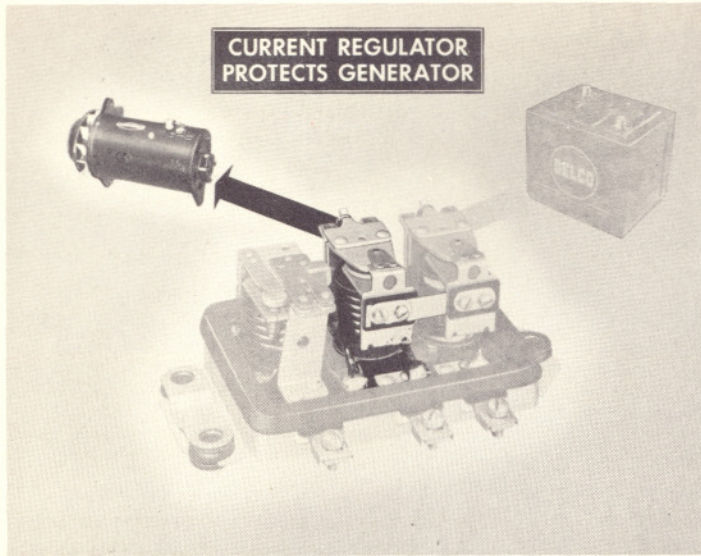

results in a tapering charge rate thus protecting the battery from overcharge and the system from high voltage.

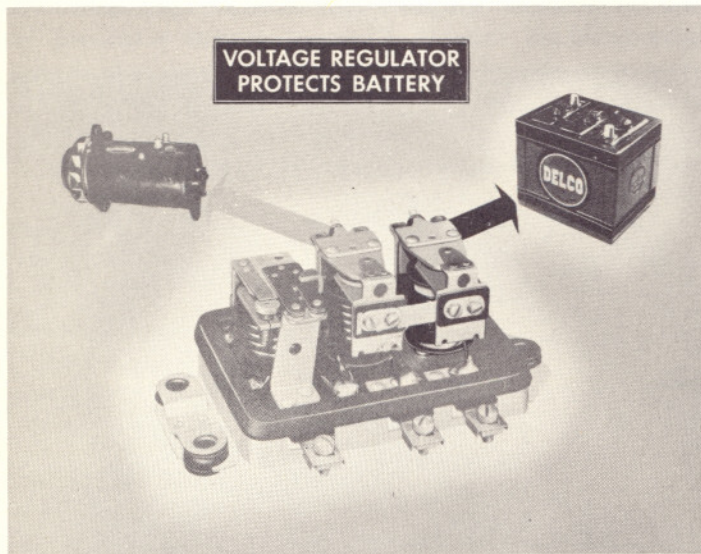

Since the cutout relay, the voltage regulator and the current regulator are mounted as one unit, it is advisable to check the entire generator regulator when any adjustment is required. A diagnosis or a system of "quick checks" readily determines whether or not the generator regulator does need adjustment, when some abnormal condition exists in the car electrical system.

With a fully charged battery and a high charging rate, connect a test ammeter into the circuit at the "BAT" terminal of the regulator, and disconnect the lead from the "F" terminal of the regulator to determine whether it is the regulator or some other unit of the electrical system which is causing the condition. This takes the regulator completely out of the generator field circuit and the output should normally drop to zero. If the output is not zero with the generator operating at a medium speed, disconnect the field lead at the generator field terminal.

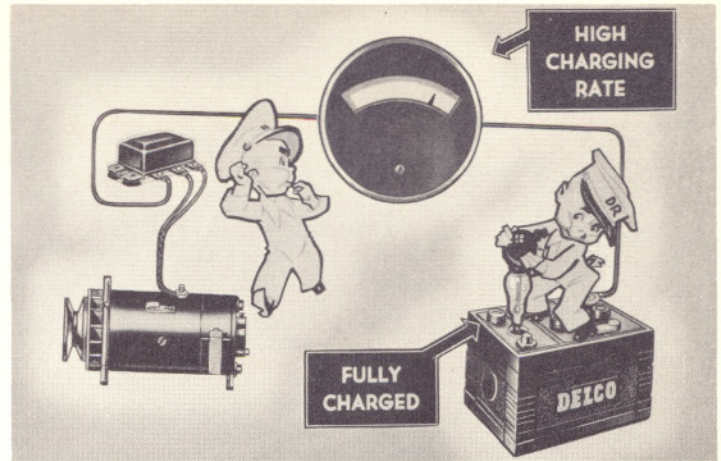

If the output then drops off, the trouble is a grounded field wire between the regulator and the generator. If

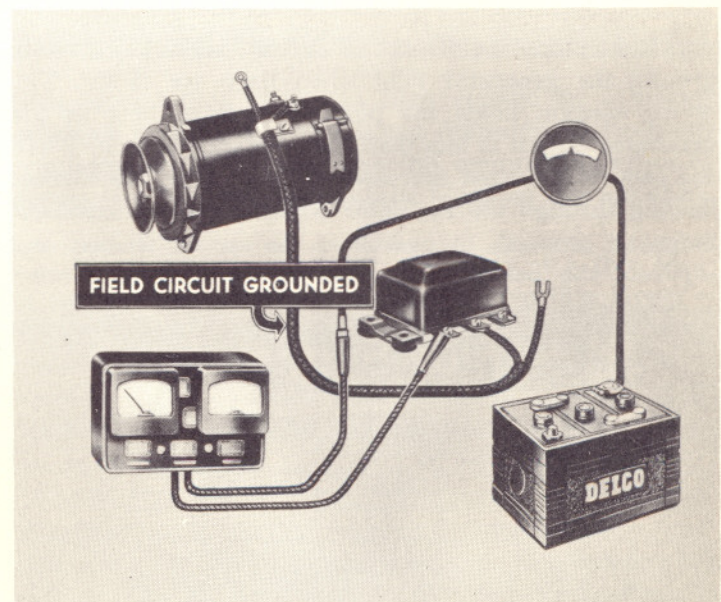

the output does not drop off under either of these checks, the generator is at fault and should be removed from the engine for further check.

If the output does drop to zero, when the lead is disconnected from the "F" terminal of the regulator, the regulator should be checked for a high voltage setting or grounded field circuit in the regulator. With the "F" terminal lead reconnected and the regulator cover removed, it is possible to determine whether the field circuit is grounded inside the regulator by depressing the voltage regulator armature. With the armature down, the output will drop to zero if the field circuit is normal, but will remain high if a ground exists. The above checks are made without benefit of a voltmeter. Whenever voltage settings are questioned, an accurate reading voltmeter should be used. It must be remembered, however, that when battery temperatures are abnormally high, the



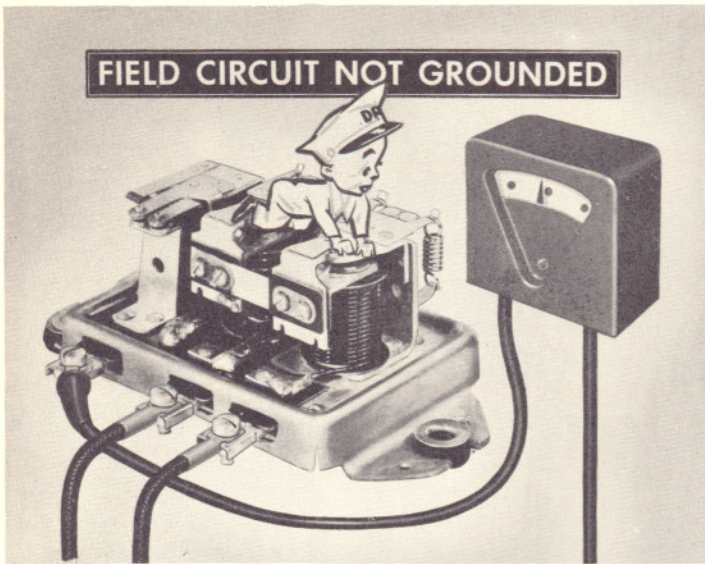

charging rate may also be high, because of battery characteristics, even though the voltage regulator setting is satisfactory for normal battery temperatures. Therefore, in hot climates, or on applications where high temperatures are common, it may be necessary to reduce the

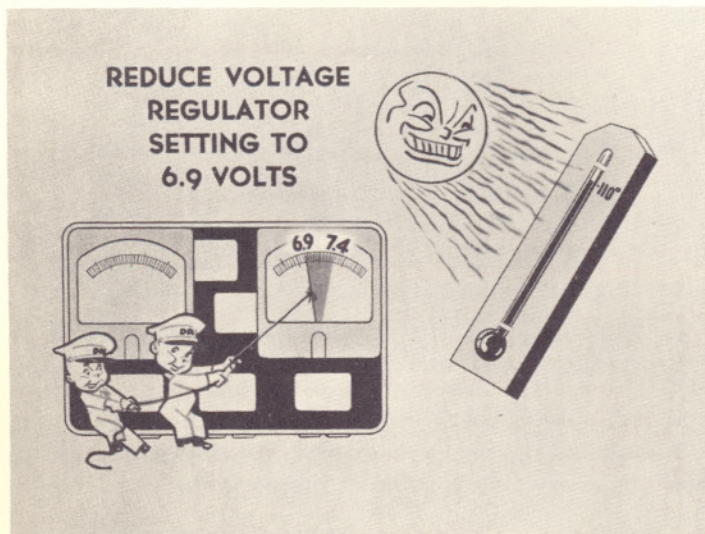

voltage regulator setting to as low as 6.9 volts in extreme cases instead of the specified 7.0 - 7.7 volts. The voltage should not be lowered for occasional trips as a normal setting would prove more satisfactory. When a reduction is made, care must be taken that the cutout relay closing voltage is approximately .5 volt lower than the voltage regulator.

With a low battery and a low charging rate, first check the voltage. If the system voltage is normal, check for voltage drop in the charging circuit between the regulator and the battery. Voltage drop may be found in

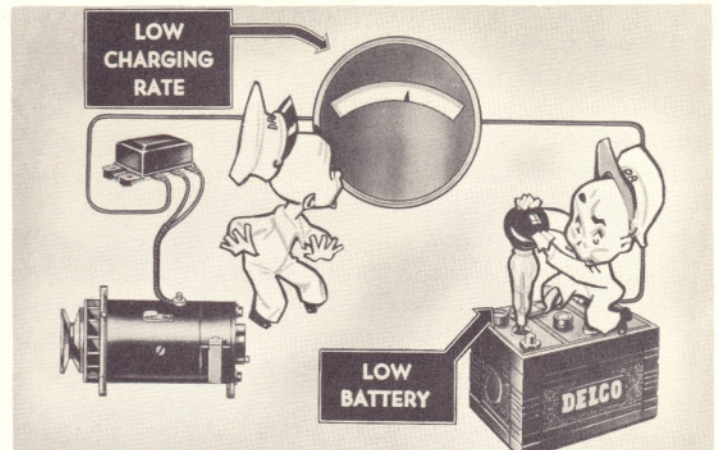

defective leads, loose connections at the ammeter or other junction points which cause high resistance in the charging circuit. When high resistance is present, the voltage

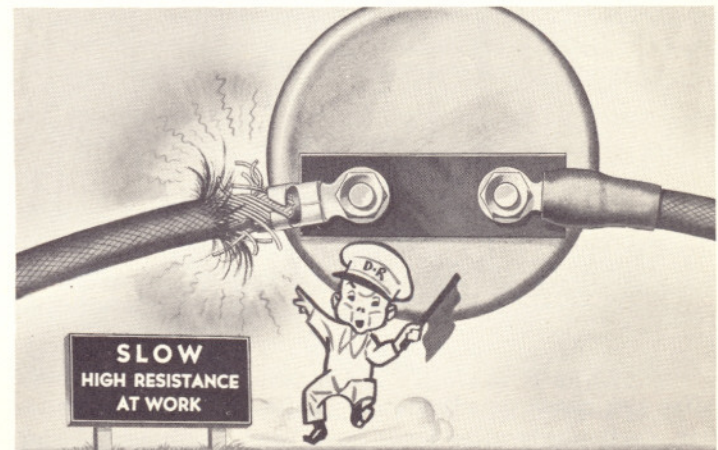

regulator will operate as if the battery were fully charged, even though the battery is in a discharged condition. A sulphated or defective battery may also be responsible for this condition.

If the system voltage is low, momentarily ground the "F" terminal of the regulator with the generator operating at a medium speed. If the output increases, check the regulator for oxidized contact points or a low voltage

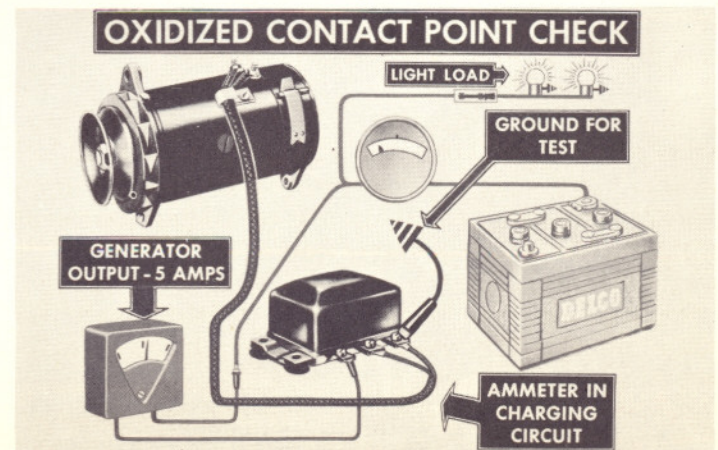



# DELCO-REMY GENERATOR REGULATORS

setting, either of which would prevent the generator from producing rated output. To check for oxidized contact points, insert an ammeter at the "BAT" terminal of the regulator, turn on head lights and operate engine at a speed which will produce approximately 5 ampere output. Ground the "F" terminal. If output increases more than 2 amperes, oxidized points are indicated and both voltage and current regulator points should be cleaned. If the output remains low, check the generator as the source of trouble. If no output at all is obtained from the generator, make sure the cutout relay is operating, since it may be failing to close, due to either a high voltage setting or an open voltage winding.

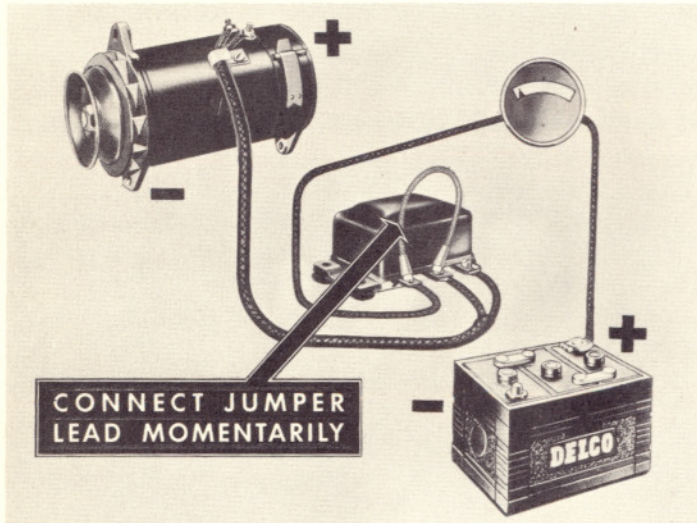

After any check or adjustment of the regulator or generator, particularly after leads have been disconnected and then reconnected, a jumper lead must be connected momentarily between the "BAT" and "GEN" terminals of the regulator, *before the engine is started*. This causes a momentary surge of current to the generator which correctly polarizes it with respect to the battery. This

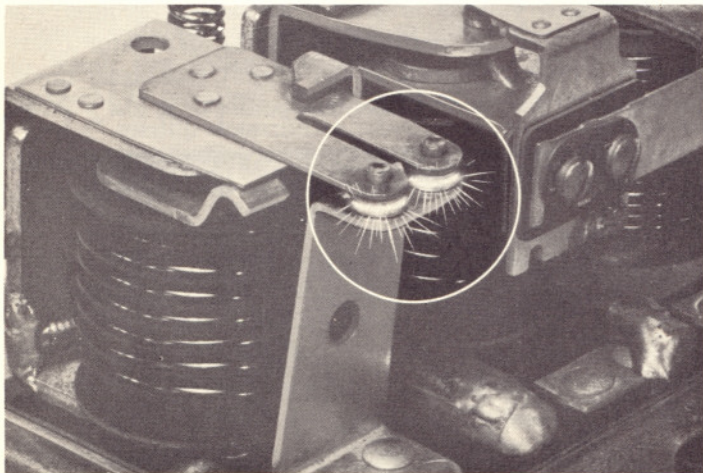

will prevent fluttering, arcing and burning of the cutout relay points which would result if the generator were wrongly polarized with respect to the battery.

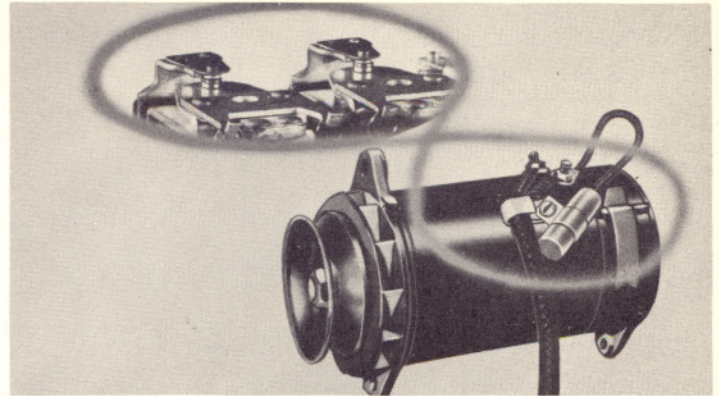

On the current and voltage regulator, pitted contact points will result from the installation of a radio by-pass condenser on the field terminal of the regulator or generator or from using the wrong model regulator for the application. Each model regulator is designed to operate with a particular model generator and a definite polarity system. Regulators must never be interchanged unless one model is actually superseded in the catalog by another.

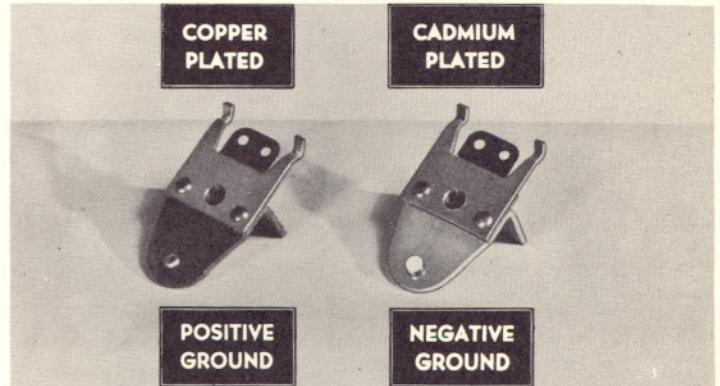

As a safeguard against installation of the wrong polarity regulator, the regulators designed for positive grounded systems have copper plated current and voltage regulator armatures, while the regulators for negative grounded systems have cadmium plated armatures. Late model regulators also have model, voltage, and polarity clearly stamped on the base of the regulator.

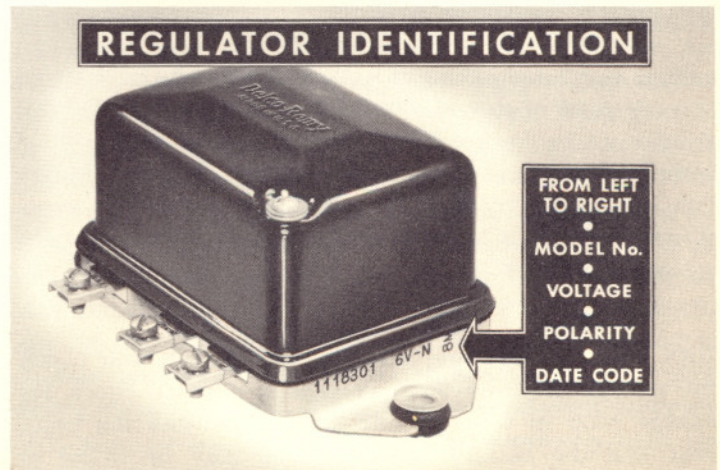



# DELCO-REMY GENERATOR REGULATORS

Copper plated armatures have platinum contacts and cadmium plated armatures have tungsten contacts. Whenever the contacts break the field circuit of a generator, there is always a small arc which tends to transfer material. The hot side of the arc, where metal tends to oxidize, is always on the positive side of the circuit so

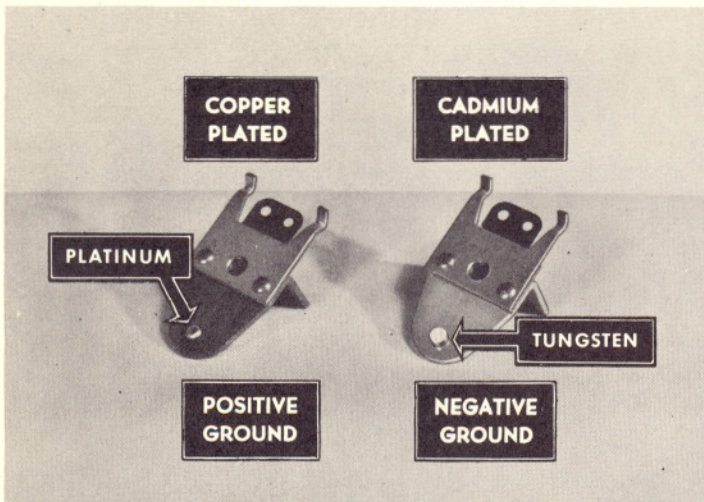

we make this point of platinum which tends to oxidize less than any other known metal. The cold side of the arc from which the metal tends to transfer is on the negative side of the circuit so we use tungsten which tends to transfer less than any other known metal. Maximum point life is obtained with this combination.

Open circuit operation of the standard duty type regulator will cause burned ignition contact points as well as burned resistances and windings in the regulator. With any of these conditions, check the car wiring carefully

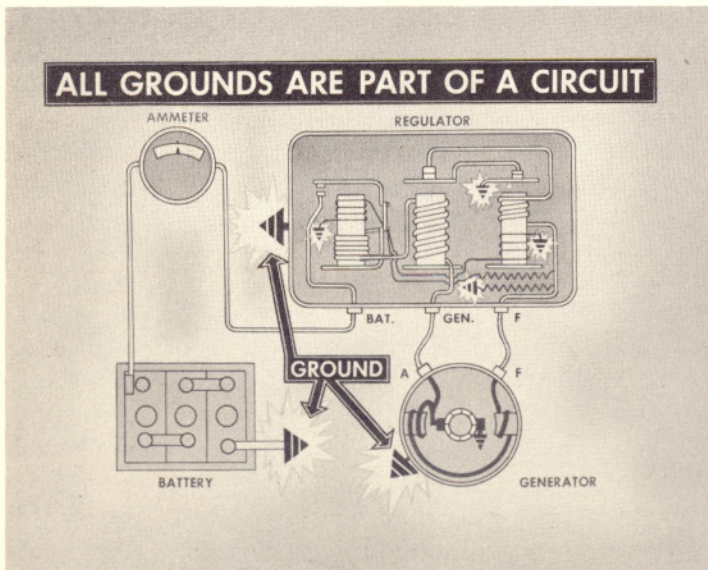

before reinstalling the regulator. The ground connections at the generator, regulator and battery are as much a part of the circuit as the wiring. Be sure a good ground exists at these units.

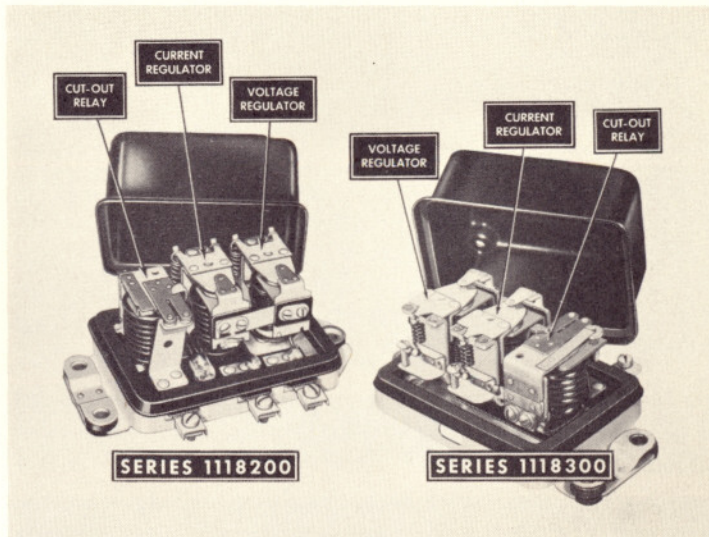

Two types of standard duty circuit regulators are now in common use, the 1118200 series and the 1118300 series. All 1118200 series regulators will be superseded by the 1118300 series, but the supersession is not reversible. All generators having plastic-coated field coils must use a regulator of the 1118300 series. Generators having taped or cloth-covered field coils may use regulators of either series as long as all other features are correct. In covering the checking of regulators, the procedure will be to show the 1118200 series first and all 1118300 series exceptions will then be noted.

The first unit to check on the regulator if adjustment is required is the cutout relay. There are three checks to be made on the relay:

1. Air Gap
2. Point Opening
3. Closing Voltage

The air gap between the center of the winding core and the armature should measure .020 inch and should be checked with the contact points barely touching. If both

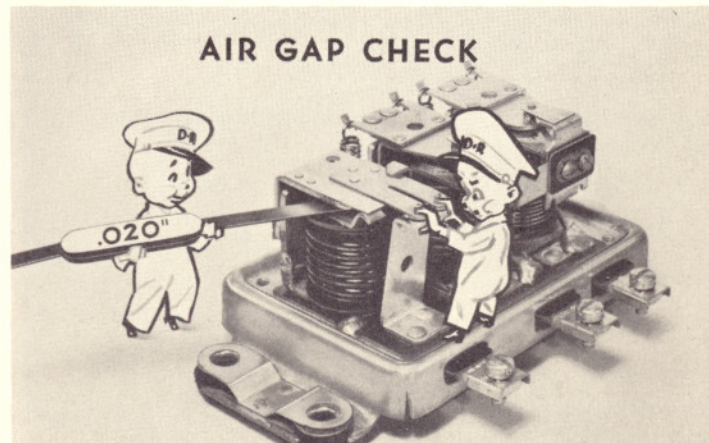

sets of points do not meet at the same instant, bend the spring fingers until they do. To adjust the air gap, loosen



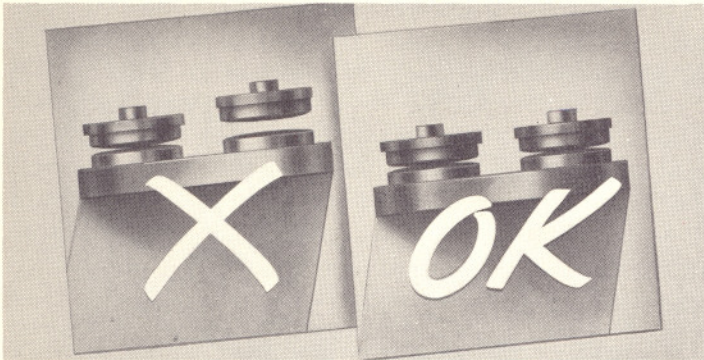

the two adjusting screws and raise or lower the armature as required. Tighten screws well after adjustment is completed.

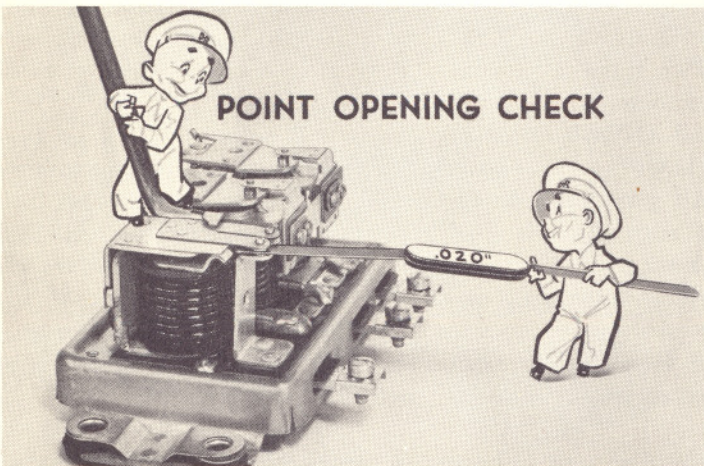

The point opening should measure .020 inch and is adjusted by bending the upper armature stop.

To check the relay closing voltage, connect a voltmeter between the "GEN" terminal and the regulator base. Slowly increase generator speed until the relay contact points close. (A 15 ohm-25 watt for 6 volt or 25 ohm-25 watt for 12 volt variable resistance connected in the field circuit may be used with the generator operating

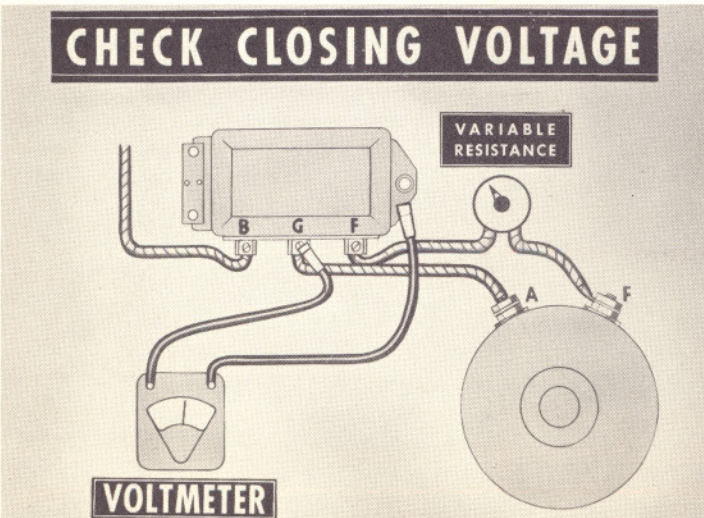

at medium speed. Slowly decreasing the resistance until the relay contact points close will also give the closing voltage setting.)

To adjust the closing voltage of the cutout relay on the 1118200 series of regulators, bend the spring post up to increase the closing voltage and down to lower the closing voltage.

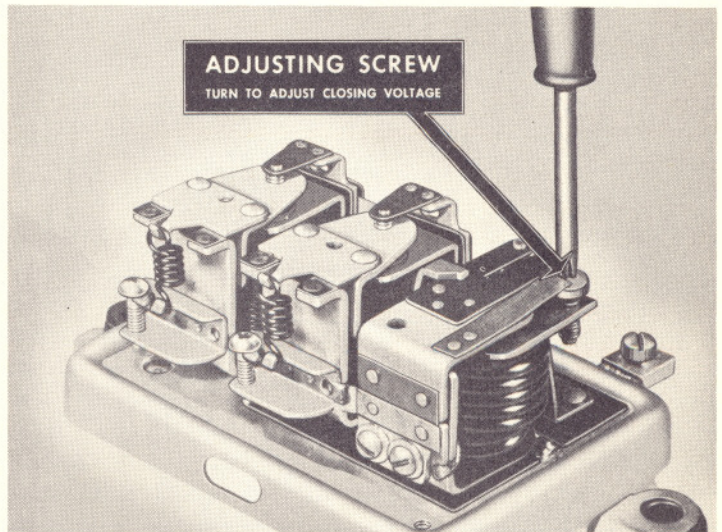

On the 1118300 series of regulators, the closing voltage is adjusted by turning the adjustment screw clockwise to increase spring tension and closing voltage and turning the screw counterclockwise to decrease spring tension and closing voltage. This is a left-hand screw.

Two checks are required on the voltage regulator, air gap and the voltage setting. For the air gap check, open the points by hand and slowly release the armature until the points *just touch*, then measure the air gap between the center of the winding core and the armature. The gap should be .070 inch on 200 series regulators and .075 inch on the 300 series regulators.

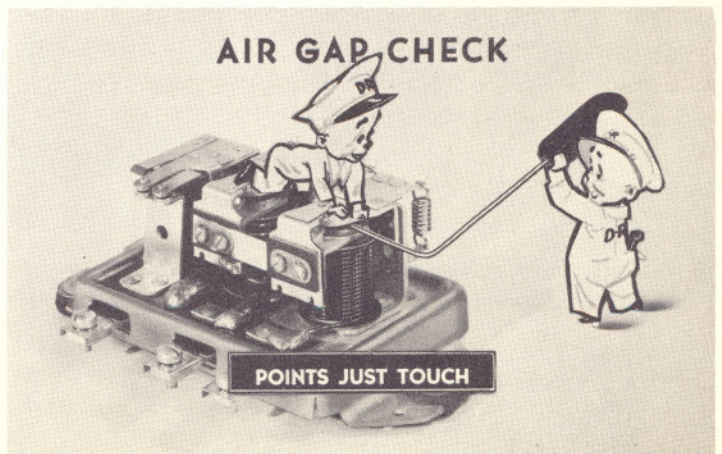

To adjust the air gap, insert gauge between armature and core, press armature down against gauge, loosen the two contact mounting screws and raise or lower the



TO ADJUST AIR GAP

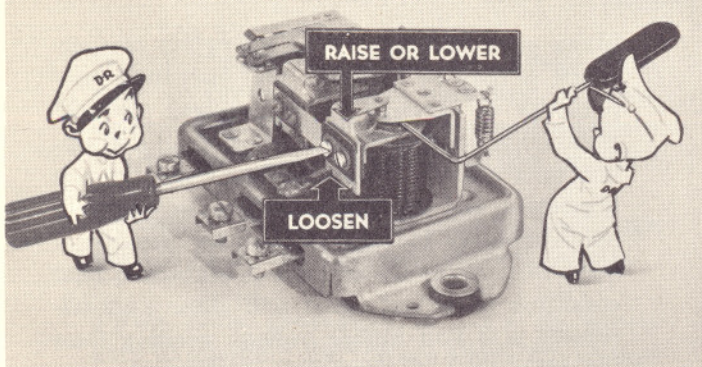

upper contact bracket as required. Make sure the points line up properly and tighten the screws well after adjustment.

There are two recommended methods of checking the voltage setting of the voltage regulator:

1. Fixed Resistance Method
2. Variable Resistance Method

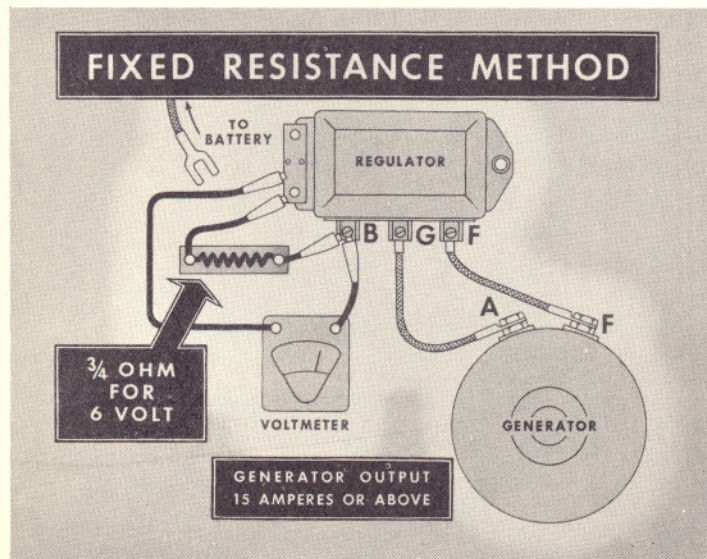

To check by the fixed resistance method, disconnect the lead from the "BAT" terminal of the regulator and connect the fixed resistance and a voltmeter in parallel from this same "BAT" terminal of the regulator to the regulator base. With generators having a capacity of 15 amperes or more, a  $\frac{3}{4}$  ohm fixed resistance is required for 6 volt systems and a  $1\frac{1}{2}$  ohm fixed resistance for 12 volt systems. These resistances will allow a flow of 8-10 amperes while the regulator is being set, and must be capable of carrying 10 amperes continuously without any change in resistance with temperature changes. With generators having a maximum output of less than 15 amperes, the  $1\frac{1}{2}$  ohm resistance should be used in 6 volt systems and a  $2\frac{1}{4}$  ohm unit in 12 volt systems, thus allowing a flow of 4-5 amperes. A 7 ohm unit is used in all 24 volt standard duty systems. Note the voltage

FIXED RESISTANCE METHOD

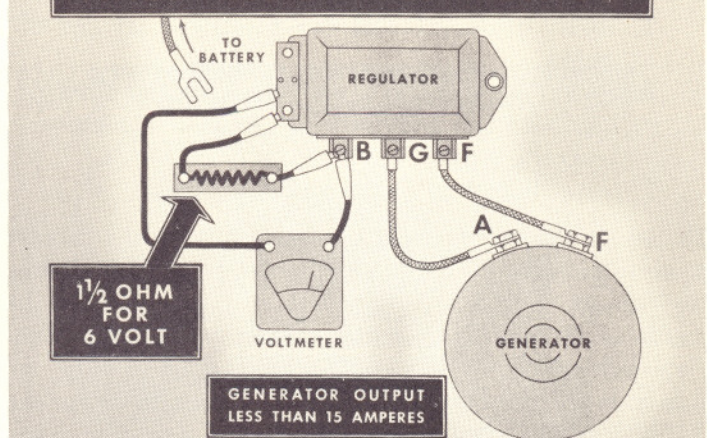

setting with the regulator at operating temperature and the generator running at a medium speed. The regulator cover must be in place. Cycle generator and repeat test.

VARIABLE RESISTANCE METHOD

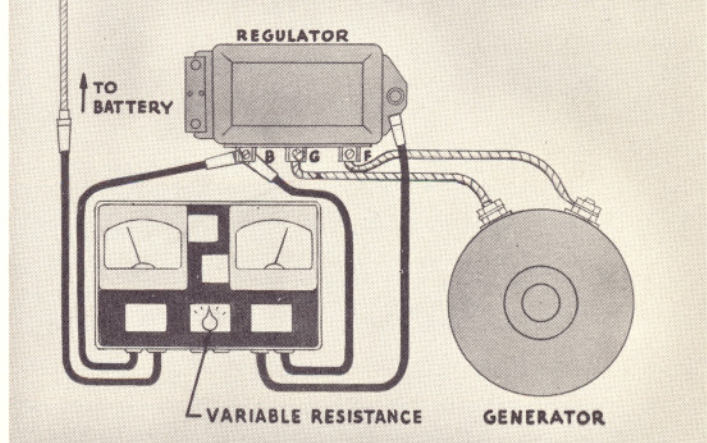

To check the voltage regulator setting by the variable resistance method, a  $\frac{1}{4}$  ohm variable resistance, an ammeter, and a voltmeter are required. Any good combination testing instrument which includes these units may be used. Connect the ammeter and the variable resistance in series into the charging circuit at the "BAT" terminal of the regulator, and connect the voltmeter from the "BAT" terminal to the regulator base. Operate the generator at medium speed. If less than 8 amperes are produced, turn on the lights to permit increased generator output. Cut in resistance slowly until the generator output is reduced to 8-10 amperes and then after cycling the generator, note the voltage. Regulator cover must be in place, the regulator must be at operating temperature, and 8-10 amperes must be flowing in the line.

After any change of setting readjust the variable resistance to return the current to 8-10 amperes, replace cover and cycle generator before taking the voltage reading.



# DELCO - REMY GENERATOR REGULATORS

Generator R.P.M. for ADJUSTING the Voltage Regulator of the Standard Duty Regulator

1. 3500 generator R.P.M. for passenger car and trucks.
2. Operating speed for constant speed engines (light aircraft engines included in this classification).
3. Governed speed for governed engines.

To adjust the voltage setting, bend one spring hanger down to increase the setting or up to decrease the setting. Adjustment should be confined to one spring unless the regulator is completely out of adjustment. For a complete adjustment, bend this one hanger up so only one spring is effective and connect a voltmeter from the "GEN" terminal of the regulator to the regulator base.

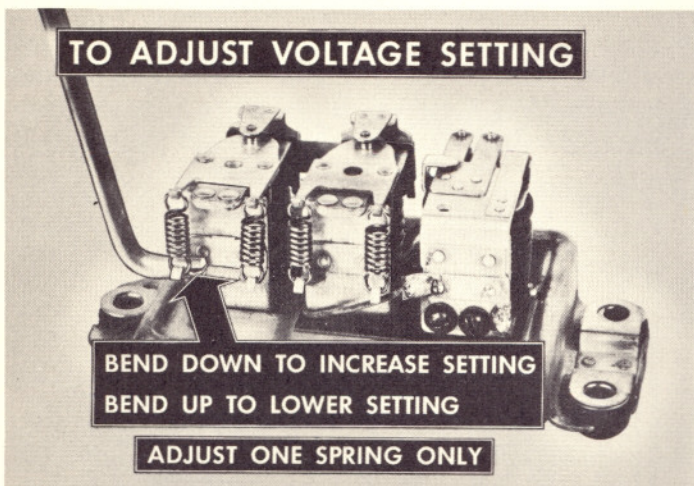

Operate the generator at specified speed. Adjust the spring tension so that regulator operates at 2/3 of the specified setting. Connect the voltmeter and fixed resistance from the battery terminal to ground, and complete adjustment on second spring to specified voltage without again touching the first spring. This procedure insures that each spring will carry one-half the total tension.

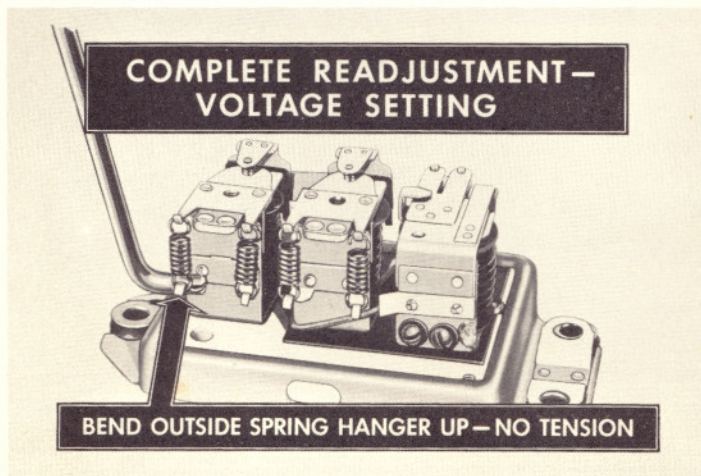

Repeat after each change of setting, to check the adjustment:

1. Make sure regulator is at operating temperature. It may be assumed that operating temperature is reached after not less than 15 minutes of continuous operation on closed circuit on a vehicle. A stabilized heat condition is important and regulators heated in ovens to approximately 145° should also be operated at least 10 minutes under load. A stabilized heat condition on a test stand will show approximately a .3 volt higher voltage reading than the same type of operation on the car.
2. Replace regulator cover.
3. Cycle generator until voltage drops below 2 volts on 6 volt system, or 4 volts on 12 volt system and bring generator back to speed.

With only one spring used for the adjustment on the 1118300 series of regulators, it is necessary simply to operate the generator at specified speed and make the adjustment of voltage with the fixed resistance as a load.

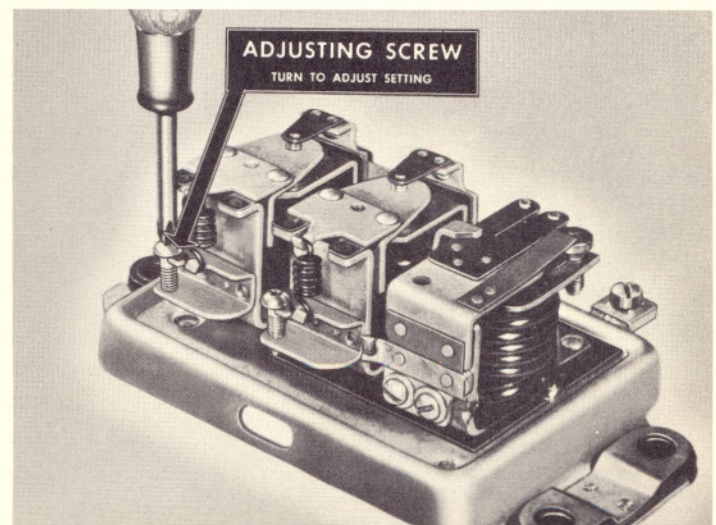

The current regulator requires two checks, the air gap and the current setting. The air gap is checked and adjusted in exactly the same manner as on the voltage regulator, except that the current regulator air gap is .080 inch on 200 series and .075 on the 300 series. To check the current regulator setting, connect a jumper lead across the points of the voltage regulator to prevent it from operating and connect a test ammeter into the circuit at the regulator "BAT" terminal. With the regulator at operating temperature, turn on the lights and accessories to prevent high voltage; run the generator at proper speed (see note on page 13) and note the current setting. Care should be taken not to open the circuit while the generator is in operation as a very high voltage would result.



NOTE: The following requirements must be observed when adjusting the current regulator:

1. With a jumper lead across the voltage regulator to prevent it from operating, all generators must be operated at a speed sufficient to produce current in excess of the specified setting.
2. Voltage of the generator must be kept high enough to insure sufficient current output.

(With some generators it may be necessary to maintain the voltage above the voltage regulator setting. This can be done, where necessary, by decreasing the load across the battery or by raising the state of charge of the battery.)

To adjust the current setting, bend one spring hanger down to increase the setting or up to lower the setting. Adjustment should be confined to one spring unless the regulator is completely out of adjustment. For complete adjustment, bend hanger so only one spring is effective. Operate the generator at specified speed. Adjust the spring tension so that regulator operates at 2/3 of the specified setting. Complete adjustment on second spring to the full current setting without again touching the first spring. This procedure insures that each spring will carry one-half the total required tension.

On the 1118300 series of regulators it is necessary only to turn the adjustment screw for the specified setting with generator operating at specified speed.

One of the most important operations the service man will be called on to perform is the cleaning of regulator contact points, and care must be used to insure that this cleaning operation is carried out successfully. The points

the upper contact bracket can be swung to one side; or the contact bracket can be removed if necessary.



Emery cloth or sandpaper should never be used to clean contact points, since particles of emery or sand may embed in the contacts and prevent normal operation.

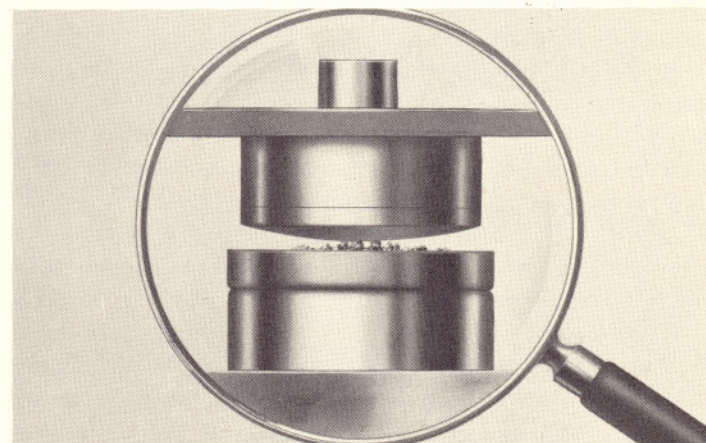

A flat file cannot successfully be used to clean flat contact points. A flat file will not touch the center of the flat point, and will not clean out the slight cavity formed in the point surface in normal operation.

If new upper contact points are required, or if the upper contact brackets have been removed, they may be re-

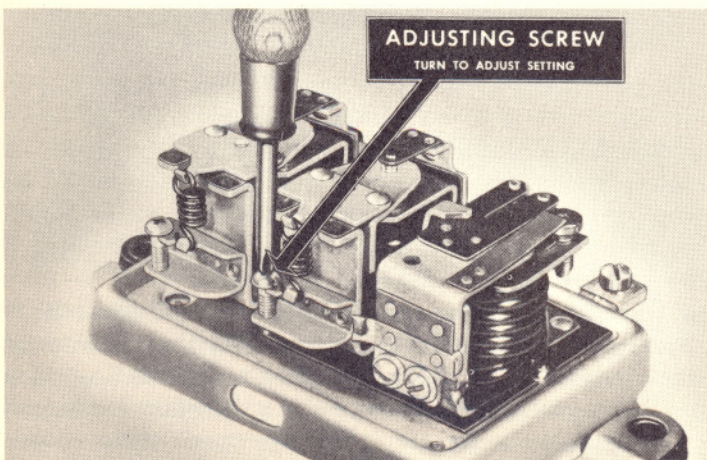
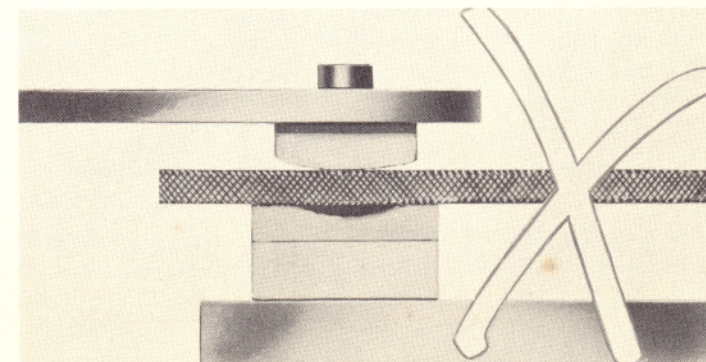

should be cleaned one at a time with a spoon or riffer file. Loosen the two contact mounting screws so that



# DELCO - REMY GENERATOR REGULATORS

assembled as shown here. Note that the connector strap is connected to the voltage regulator upper contact bracket, while it is insulated from the current regulator

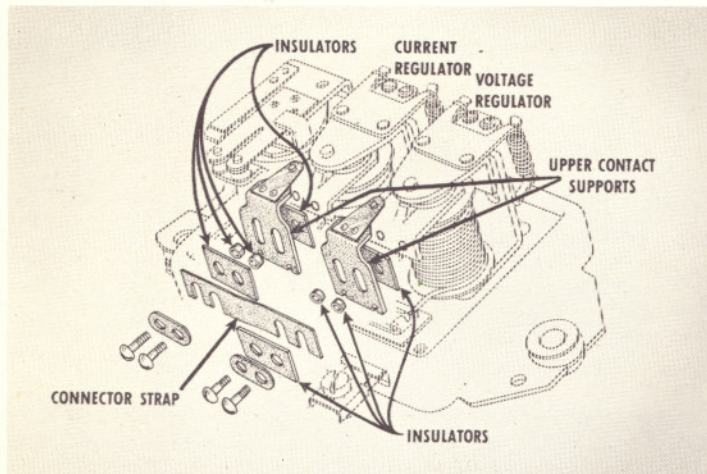

upper contact bracket. The air gaps must be reset as previously explained.

The armatures may be replaced on the 1118200 series of regulators by drilling out the two rivets which mount the armature hinge spring on the regulator frame. Support the frame to avoid bending it, center punch the rivet heads, and use a 3/32 drill. Assemble the new armature with the screws, lockwashers, and nuts supplied with the service armature. Assemble screws down so that they will not ground against the regulator cover. The armatures on the 1118300 series are welded and cannot be replaced in service.

The story of regulation as outlined in the beginning is the function of inserting a resistance in the field circuit of a generator and taking it out again at the right time.

The contact points of the regulator, either the voltage or current unit, perform this work 50 to 200 times a second. An arc occurs every time the points separate and some oxidation is bound to occur. While the point materials

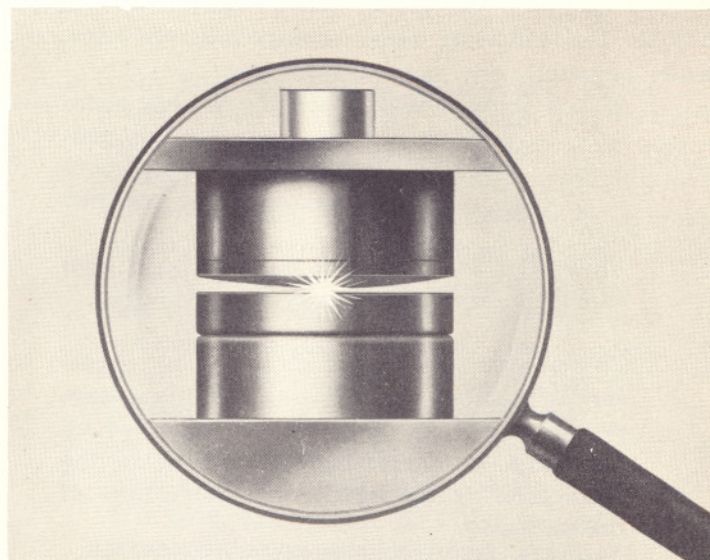

used are the best known for the purpose, cleaning points properly to remove all oxides necessarily becomes a regular service function because of the amount of work they do.

It is estimated that 90% of regulator troubles can be traced directly to dirty or oxidized contacts. The tung-



sten point on the negative side is always the point with the slight cavity and the one which requires the most attention. **CAUTION:** The opposite contact point is platinum which is a relatively soft metal and should be filed *very* lightly to avoid excessive loss of metal. Never try to file both points at the same time by drawing a file between them. Cleaning the points down to pure metal, with a riffler file, will insure long periods of service without comebacks, but the fact that an attempt was made to clean the points does not mean that they are clean and comebacks are the rule when haphazard cleaning methods are employed. Too much stress cannot be put on the necessity for clean contacts and service men should make it a rule never to clean points unless the job is done right.

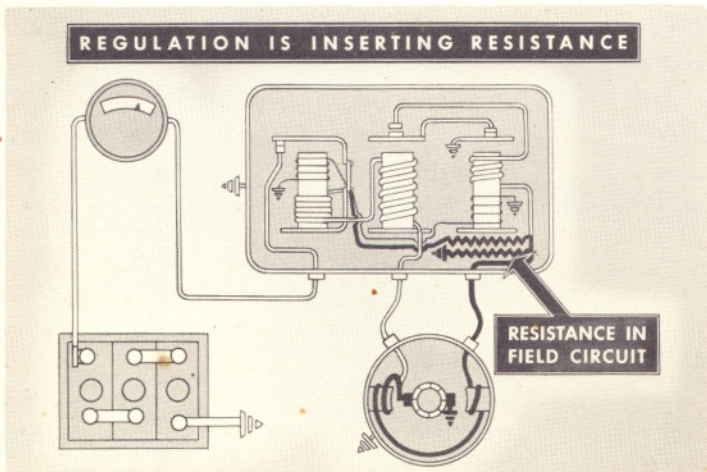



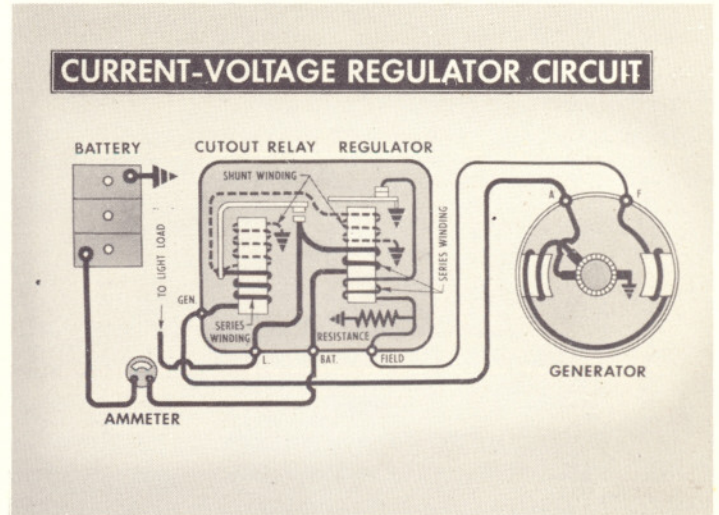
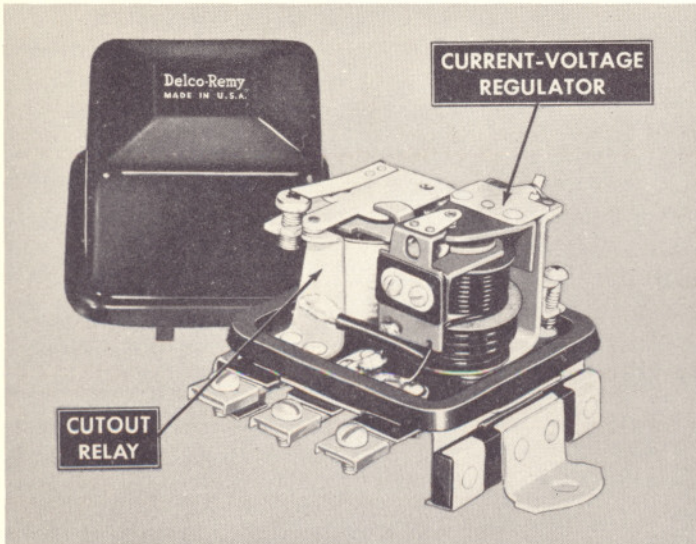

A new type of generator regulator known as the combined current-voltage type has been produced for special applications. Farm tractor operation is one of the services which require a special regulator to give satisfactory performance. Available standard equipment allowed excessive charging rates during long continued periods of summer operation unless voltage settings were lowered. With the lowered settings insufficient charge was obtained during cold weather operation. In both cases, premature battery failures occurred.

This special regulator is used in conjunction with a third brush generator which acts as a safety device to prevent excessive output when the battery is run down or improper loads are connected.

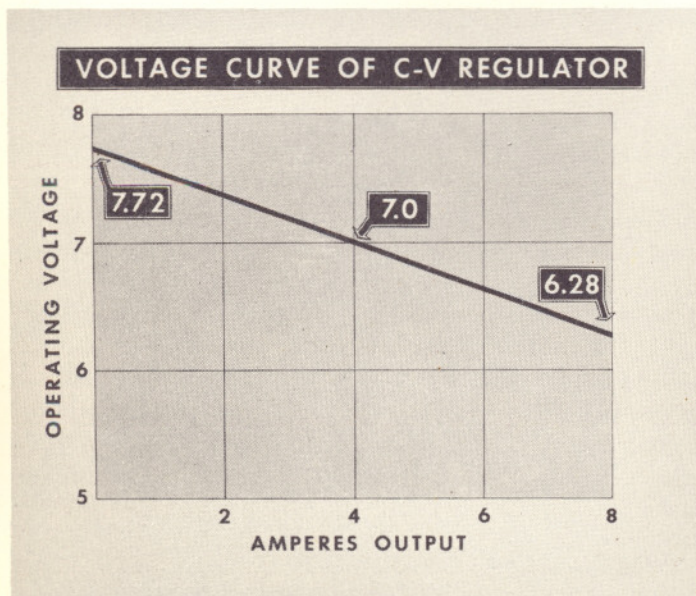

With Delco-Remy combined current-voltage regulators, tractor type batteries are giving better than average life because the charging rate even to a hot battery, with a properly set regulator, does not exceed a normal charging rate of approximately 1 ampere per positive plate per cell. It is also possible to get some charge to the battery in cold weather due to the higher voltage operation possible when the charging current is low.

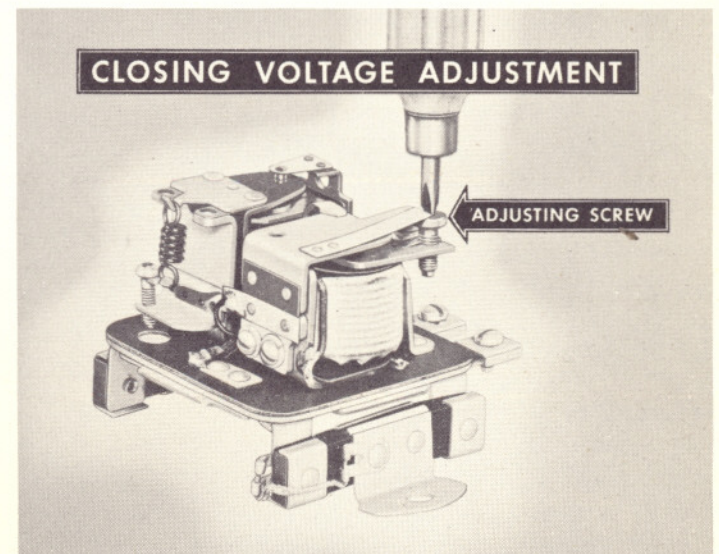

The cutout relay operation and the method of adjustment is the same as outlined for the 1118200 and 1118300 series of standard regulators. The regulation of generator voltage and current output, however, is entirely different. A voltage-sensitive shunt winding and a current-sensitive series winding are wound on the same core and both windings work together to insert a resistance in the field circuit. The voltage winding acts like any normal voltage regulator and prevents the system voltage from exceeding a predetermined value. When the battery is cold or fully charged and its counter voltage is high, very little current flows to the battery. When the battery is low a normal voltage setting on a standard regulator would cause a continued high charging rate, but on the tractor regulator the current-sensitive series winding modifies the regulator action by aiding to pull the armature down



**SERIES WINDING MODIFIES OPERATING VOLTAGE**

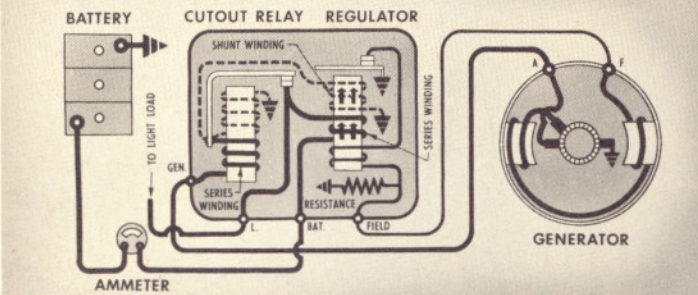

to lower the operating voltage. A high output is thus obtained only when the battery needs a charge, and the amount of charging current is controlled so that batteries are not subjected to overcharge, one of the main reasons for battery failures.

Setting of the current-voltage regulator unit is made only with a fixed resistance connected from the "Battery" terminal of the regulator to "Ground" on the regulator base and with the battery lead disconnected. A 6.9 volt reading with a 1.5 ohm unit is normal for 6 volt systems. A 14 volt reading with a 7 ohm unit is normal for 12 volt systems. A variation of plus or minus .3 of a volt is the range of setting for operating requirements on 6 volts. This range is -.4 of a volt to +.5 of a volt on the 12 volt system. Voltage readings may be taken at 2500 r.p.m. of the generator with the regulator at the stabilized operating temperature.

Satisfactory regulator service depends upon applying the following basic rules and principles:

1. Use the right polarity regulator.
2. Always polarize generator after working on the electrical system.
3. Cycle generator after every change in regulator adjustment.
4. Check all standard duty regulators on closed circuit.
5. Regulators must be at a stabilized operating temperature when tested.
6. Make settings according to specification.
7. All contact points eventually oxidize and must be cleaned.
8. A hot battery can upset regulation.

**LIGHTING CURRENT BY-PASSES REGULATOR**

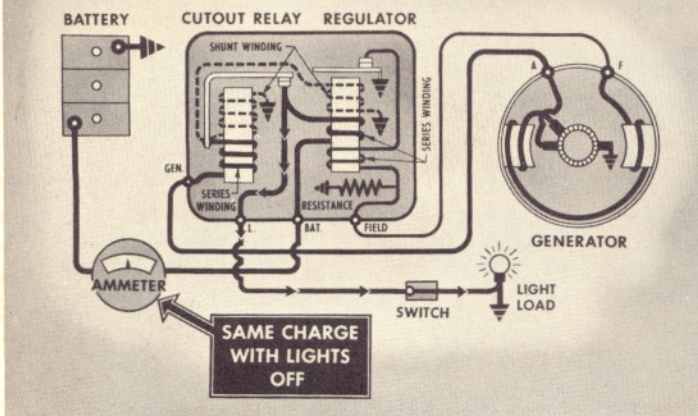

A feature of the combined current-voltage regulator is that generator output increases as the electrical load is added to the "L" terminal of the regulator. Since the load current by-passes the regulator current winding, it has no effect on the battery charging rate as long as the total load does not exceed the maximum output of the generator at operating speed.

These simple rules for checking will eliminate many causes of trouble, but the fundamentals brought out in this story should not be overlooked. There is no magic about generator regulators, they are nothing more than limiting devices. The system voltage may be maintained within specifications and yet the customer's battery becomes overcharged; or another customer with the same voltage setting may have difficulty keeping the battery in a charged condition. The long-distance, high-speed driver will normally receive better service from a lower voltage adjustment, while the short-distance, slow-speed driver, operating in city traffic, will have a better chance of keeping the battery charged by selecting a voltage adjustment toward the high side of the specification limits.

**SETTING CURRENT-VOLTAGE REGULATOR**

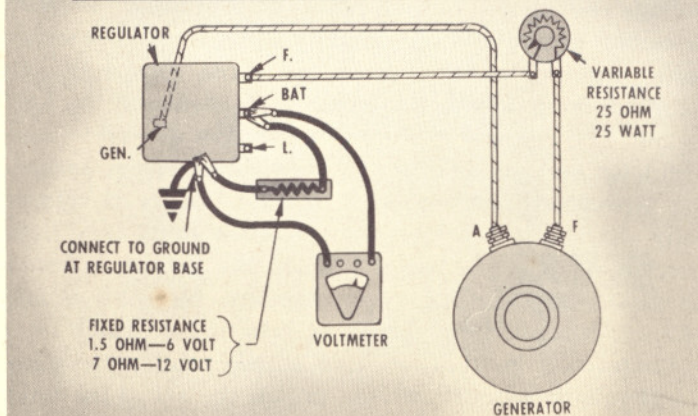

Cars operated in northern climates require higher voltage settings than cars operated in tropical areas because a high voltage is necessary to force any charge into a battery when it is cold.

Electrical service men should always keep these variations in mind. None of the procedures for checking should be by-passed, but the most satisfactory voltage adjustment which can be used by any customer is the setting which will keep the battery charged with the least amount of water consumption.



Delco-Remy operates nine plants in Anderson, Indiana, and employs 12,000 men and women in the manufacture of automotive electrical equipment. Standard duty generator regulators assembled on this "line" in one of the Delco-Remy plants go into the electrical systems for passenger cars, trucks, farm tractors, aircraft, and other engine applications in use around the world.

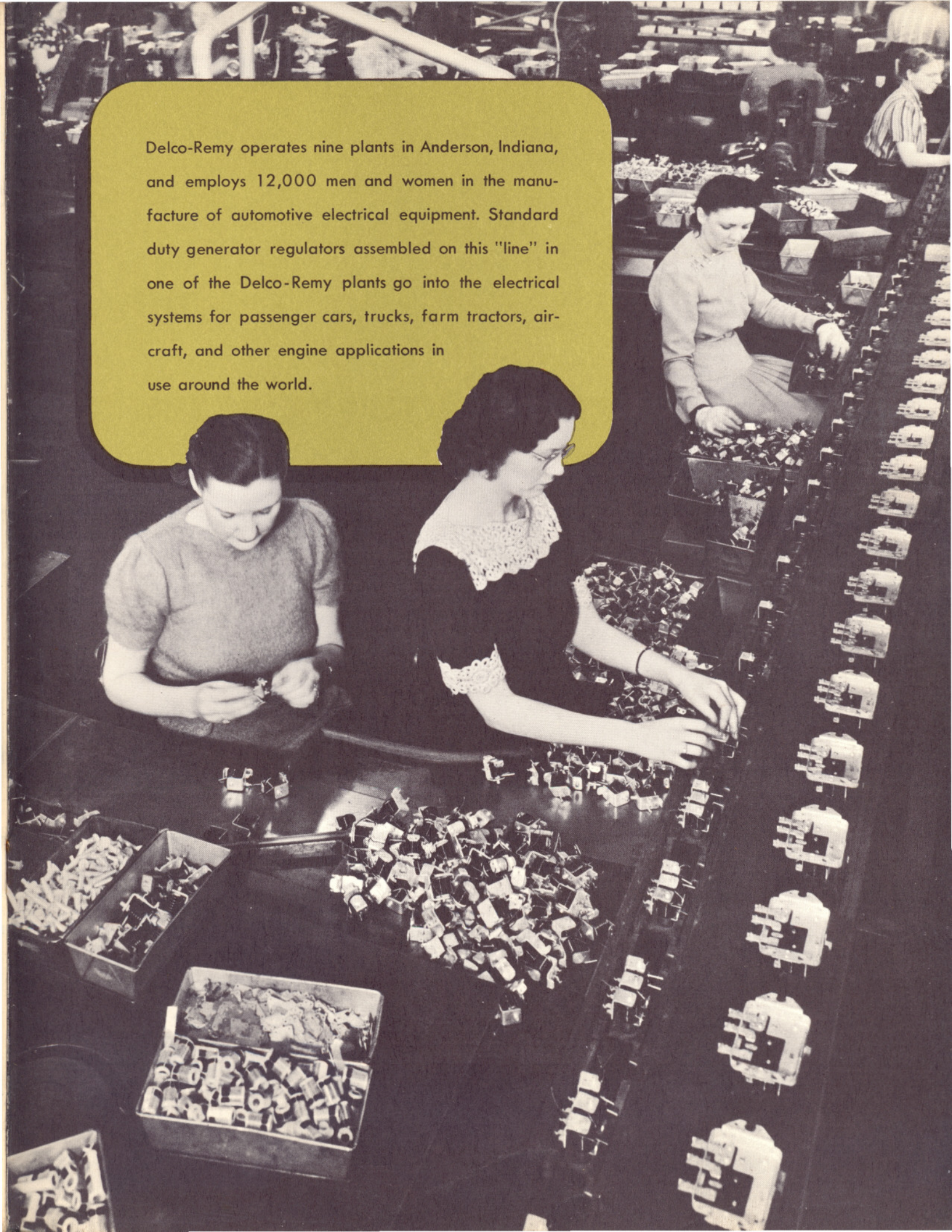



# DELCO-REMY

## **ELECTRICAL EQUIPMENT**

PASSENGER CARS • COMMERCIAL CARS  
MOTOR COACHES • MARINE ENGINES  
INDUSTRIAL ENGINES • AIRCRAFT  
TRACTORS • TRUCKS

Parts and service on all Delco-Remy units are  
available at United Motors Service Stations