

Bendix/King®
GPS/COMM



WARNING

Information subject to the export control laws. This document, which includes any attachments and exhibits hereto, contains information subject to International Traffic in Arms Regulation (ITAR) or Export Administration Regulation (EAR) of 1979, which may not be exported, released or disclosed to foreign nationals inside or outside the U.S. without first obtaining an export license. Violators of ITAR or EAR may be subject to a penalty of 10 years imprisonment and a fine of \$1,000,000 under 22 U.S.C. 2778 or Section 2410 of the Export Administration Act of 1979. Include this notice with any reproduced portion of this document.

COPYRIGHT NOTICE

©1996 AlliedSignal, Inc.

Reproduction of this publication or any portion thereof by any means without the express written permission of AlliedSignal Commercial Avionics Systems is prohibited. For further information contact the Manager, Technical Publications; AlliedSignal Commercial Avionics Systems; 400 North Rogers Road; Olathe, Kansas 66062. Telephone: (913) 782-0400.

AlliedSignal, Inc.
Commercial Avionics Systems
400 North Rogers Road
Olathe, Kansas 66062-1294
FAX: 913-791-1302
TELEPHONE: 913-782-0400

006-08789-0000
Rev. 2 4/97



KLX 135A Pilot's Guide

006-08789-0000

for KLX 135A

with

Operational Revision Status ORS 10

April 1997

Revision History and Instructions

Manual KLX 135A Pilots Guide

Revision 2, April 1997

Part Number 006-08789-0000

Typographical and spelling errors corrected on pages; 3-26, 3-41, 3-64 and 3-66. Illustration corrections on figures; 3-62 and 4-6. Database Form Corrections. Added warning and copyright notices on front cover. Added revision page R-1. Deleted EFF-1 through EFF-6 pages.

NOTE: A "whiskers" border is used around data on some of the figures in this Pilot's Guide to indicate that the data inside the border is flashing.

118.00	ZBU
136.97	BIMINI
ENT Le9	N 25
VOR 1	W 79

INTRODUCTIONi

KLX 135A SNEAK PREVIEWii

HOW-TO INDEXiv

1. KLX 135A SYSTEM COMPONENTS1-1

2. DATA BASE2-1

 2.1. Data Basics2-1

 2.2. Data Base Contents and Coverage Areas2-1

 2.3. ICAO Identifiers2-3

 2.4. Updating the Data Base2-4

 2.5. User Defined Data Base2-7

 2.6. Data Base Update Service Options2-7

3. BASIC GPS OPERATION3-1

 3.1. Coverage Area3-1

 3.2. Turn-on and Self Test3-1

 3.3. Display Format3-7

 3.4. Basic Operation of Panel Controls3-9

 3.4.1. Page Selection3-10

 3.4.2. Data Entry3-11

 3.4.3. The Duplicate Waypoint Page3-14

 3.4.4. Cyclic Fields3-15

 3.5. Message Page3-16

 3.6. Initialization and Time to First Fix3-17

 3.7. Selecting and Scanning Waypoints3-20

 3.7.1. Selecting Waypoints by Identifier3-20

 3.7.2. Selecting Waypoints by Scanning3-22

 3.7.4. Selecting Waypoints by Name or City3-23

 3.8. "Nearest" Functions3-26

 3.8.1. Viewing the Nearest Waypoints3-26

 3.8.1.1 Nearest Airport Criteria3-27

 3.8.1.2 Continuous Display of Nearest Airport3-28

 3.8.2. Viewing the Nearest Special Use Airspaces3-29

 3.8.3. Viewing the Nearest Flight Service Station
 Frequencies3-30

 3.8.4. Viewing the Nearest Center Frequencies3-31

Table of Contents

3.9. Direct to Operation	3-32
3.9.1. Initiating a Direct To	3-32
3.9.2. Canceling a Direct To	3-34
3.9.3. Waypoint Alerting for Direct To Operation	3-35
3.10. Navigation Pages	3-35
3.10.1. The Navigation 1 (NAV 1) Page	3-35
3.10.2. The Navigation 2 (NAV 2) Page	3-38
3.10.3. The Navigation 3 (NAV 3) Page	3-39
3.10.4. The Navigation 4 (NAV 4) Page	3-39
3.10.5. The Navigation 5 (NAV 5) Page	3-40
3.11. Waypoint Pages	3-45
3.11.1. Airport Pages	3-45
3.11.1.1. The Airport 1 (APT 1) Page	3-45
3.11.1.2. The Airport 2 (APT 2) Page	3-46
3.11.1.3. The Airport 3 (APT 3) Page	3-47
3.11.1.4. The Airport 4 (APT 4) Page	3-48
3.11.1.5. The Airport 5 (APT 5) Page	3-49
3.11.2. VOR Pages	3-50
3.11.2.1. The VOR 1 Page	3-50
3.11.2.2. The VOR 2 Page	3-51
3.11.3. NDB Pages	3-51
3.11.3.1. The NDB 1 Page	3-51
3.11.3.2. The NDB 2 Page	3-52
3.11.4. Supplemental Waypoint Pages	3-52
3.11.4.1. The Supplemental 0 (SUP 0) Page	3-52
3.11.4.2. The Supplemental 1 (SUP 1) Page	3-53
3.11.4.3. The Supplemental 2 (SUP 2) Page	3-53
3.11.4.4. The Supplemental 3 (SUP 3) Page	3-54
3.12. Viewing and Setting the Date and Time	3-55
3.13. The Other (OTH) Pages	3-57
3.13.1. Determining the Status of the GPS Signals	3-57
3.13.2. Viewing and Deleting User Waypoints and Waypoint Remarks.....	3-59
3.13.2.1. The OTH 3 Page	3-59
3.13.2.2. The OTH 4 Page	3-60
3.13.3. Viewing the KLX 135A Software Status	3-61

3.15. Special Use Airspace Alerting3-61

3.16 Sample Trip3-64

 3.16.1 Pre-departure3-64

 3.16.2 En route3-65

 3.16.3 Terminal Area3-66

4. MORE GPS OPERATION4-1

 4.1. Creating and Modifying Flight Plans4-1

 4.1.1. Creating a Flight Plan4-1

 4.1.2. Viewing Distance and Desired Track Between
 Stored Flight Plan Waypoints4-3

 4.1.3. Activating a Numbered Flight Plan4-4

 4.1.4. Adding a Waypoint to a Flight Plan4-5

 4.1.5. Deleting a Waypoint from a Flight Plan4-6

 4.1.6. Deleting Flight Plans4-6

 4.1.7. Storing FPL 0 as a Numbered Flight Plan4-7

 4.2. Operating from the Active Flight Plan4-8

 4.2.1. General Procedures4-8

 4.2.2. Turn Anticipation and Waypoint Alerting4-9

 4.2.3. Viewing the Waypoint Pages for the Active
 Flight Plan Waypoints4-11

 4.2.4. Combining Direct To and Flight Plan Operation ...4-11

 4.2.5. Viewing Distance, ETE, ETA, or Desired Track
 to Flight Plan Waypoints4-13

 4.3. Calculator Pages4-14

 4.3.1. The Calculator 1 (CAL 1) Page4-14

 4.3.2. The Calculator 2 (CAL 2) Page4-16

 4.3.3. The Calculator 3 (CAL 3) Page4-18

 4.3.4. The Calculator 4 (CAL 4) Page4-19

 4.3.5. The Calculator 5 (CAL 5) Page4-20

 4.3.6. The Calculator 6 (CAL 6) Page4-20

 4.4. Creating User-defined Waypoints4-21

 4.4.1. Creating a Waypoint at Your Present Position4-22

 4.4.2. Creating a Waypoint at a Certain
 Latitude/Longitude4-23

 4.4.3. Creating a Waypoint Referenced from
 Another Waypoint4-24

Table of Contents

4.5. Navigation Modes	4-25
4.5.1. Selecting the Leg Mode or the OBS mode	4-26
4.5.2. The En route-Leg Mode	4-26
4.5.3. The En route-OBS Mode	4-27
4.5.4. Effects of Switching From En route-OBS Mode to En route-Leg Mode	4-28
4.5.5. Activating a Waypoint While in the En route-OBS Mode	4-28
4.6. Operation Outside the Primary Coverage Area	4-29
4.7. Using the Take-home Mode	4-30
5. COMM OPERATION	5-1
5.1. Entering Frequencies	5-1
5.1.1. Frequency Selection	5-1
5.1.2. Standby Frequency Entry	5-1
5.1.3. Active Frequency Entry	5-2
5.1.4. 25 KiloHertz Channel Spacing Operation	5-2
5.1.5. Using QuickTune™ Frequency Selection	5-3
5.2. Receive/Transmit Annunciation	5-4
5.3. Volume Adjustment and Automatic Squelch Override	5-4
5.4. Stuck Microphone Protection	5-4
5.5. Blind Tuning Feature	5-5
APPENDIX A - NAVIGATION TERMS	A-1
APPENDIX B - MESSAGE PAGE MESSAGES	B-1
APPENDIX C - SCRATCHPAD MESSAGES	C-1
APPENDIX D - ABBREVIATIONS	D-1
STATE ABBREVIATIONS	D-1
CANADIAN PROVINCE ABBREVIATIONS	D-2
COUNTRY ABBREVIATIONS	D-2
ARTCC ABBREVIATIONS	D-8
OTHER ABBREVIATIONS USED ON KLX 135A PAGES ..	D-17
APPENDIX E - LAT/LON CONVERSIONS	E-1
APPENDIX F— GPS PRIMER	F-1

INTRODUCTION

Thank you for choosing the Bendix/King KLX 135A GPS/COMM. If you've never used GPS before, you'll find it will change the way you fly. The moving map graphics with special use airspace boundaries will give you an extra feeling of security during all of your time in the air. All in all, it will let you concentrate on the fun in flying, and isn't that why you learned to fly in the first place?

The convenient QuickTune™ feature will allow you to easily look up the frequency for the appropriate airport, nearest Flight Service Station, or ARTCC/FIR, then transfer it to the KLX 135A COMM transceiver.

This Pilot's Guide should be of great help to you. It is written in plain, simple English and it assumes you are not an experienced user of GPS or other type of long range navigation equipment. If you are experienced, so much the better. This Pilot's Guide also includes hundreds of sample screen figures and other illustrations to make your learning easier. It is designed so that you can start at the front and progress in the order presented; however, you may want to skip around and learn things in your own order. Also, on page iv, there is an index of frequently used procedures which will help you find the page that describes how to do exactly what you want to do. There are also several appendices in the back of the manual that you may find useful from time to time.

Be sure to keep this Pilot's Guide handy with you in the airplane. It is designed to fit easily in the glove box, or in the seat pocket. The KLX 135A is very simple to operate, but the Pilot's Guide can sure be of help to you.

One last thing. Don't get so involved in learning to use the KLX 135A that you forget to fly the airplane. Be careful, and remember to keep a close eye out for other aircraft.

KLX 135A SNEAK PREVIEW

If you absolutely can't wait to use your KLX 135A until you've read this Pilot's Guide, this section is for you. This page will teach you just enough to get going and then learn by doing. This operational preview assumes the KLX 135A has been properly installed, the unit was previously operational in the same general geographical location, and that no peripheral equipment interfaced with the KLX 135A (such as external HSIs, CDIs, autopilots, moving map display, etc.) is to be used at this time. If you are using this operational preview in flight, do so only in good VFR conditions and only with an alternate means of navigation (including pilotage) available to cross-check position.



1. Turn the unit on with the On/Off/Volume knob (the small knob in the upper left hand corner). Adjust the COMM audio volume as desired by pulling this knob out (breaking the squelch), turning it to an appropriate level and pushing it back in.
2. For a few seconds, the Turn On Page is displayed while the unit runs a self-test. Afterwards, the Self-test Page is displayed. If the KLX 135A is receiving an altitude from an encoding altimeter, the present altitude will be displayed on line 3. The bottom line should display **Pass** and a flashing **Ok?**. Press the button to approve the Self-test Page.
3. The Initialization Page will now be displayed. If the date and time are incorrect by more than 10 minutes, refer to section 3.2 of this Pilot's Guide. The right side of the screen should show the identifier of the nearest airport to the initial position, along with a radial and distance from that airport waypoint. Press with the cursor flashing over **Ok?** to approve the Initialization Page.
4. The VFR page will now be displayed to notify you that the GPS is for VFR use only. Press to approve this page.
5. A Data Base Page is now displayed showing the date the data base expires or the date it expired. Press to acknowledge the information displayed on this page.

6. The next page displayed will probably be a page showing the VHF communication frequencies for the airport you are at. For now, use the right outer knob to turn to the NAV page type (watch the lower left corner of the screen and the small bar at the bottom to know when you are there). Then use the right inner knob to select the NAV 2 page if not already there. The NAV 2 page shows your present position relative to a nearby VOR. Verify that this position is correct before proceeding.

7. Press the  button. A page with the words **DIRECT TO** is now displayed on the screen.

In step 8 you will enter the ICAO identifier of the airport. The identifier will have a "K" prefix for a Continental U.S. airport, a "C" prefix for a Canadian airport, or a "P" prefix (in some cases) for an Alaskan airport if the identifier is all letters. For example, LAX becomes KLAX. For these countries if the identifier contains any numbers, there is no prefix. For example, TX04 is entered TX04. For other areas of the world the airport identifier should be entered identically to how it is charted.

8. Rotate the right inner knob until the first character of the airport identifier is displayed. Turn the right outer knob one step clockwise to move the flashing segment to the second character position. Rotate the right inner knob to select the second character of the identifier. Use this procedure to enter the complete airport identifier.

9. Press . The display will change to a page showing the identifier, name, city, and state/country of the airport just entered. Confirm that the correct airport is displayed. Press  a second time to approve the airport data.

10. A Navigation page is now on the screen. It displays the distance, groundspeed, bearing, and ETE to the destination airport. In addition, it displays a course deviation indicator (CDI).

See--wasn't that easy?

HOW-TO INDEX

This index will help you quickly find important procedures at a glance. The list is alphabetized by action words.

<u>TO:</u>	<u>SEE PAGE:</u>
Activate a waypoint in OBS mode without changing the selected course	4-29
Activate one of the previously created numbered flight plans	4-4
Add a waypoint to a flight plan	4-5
Calculate density altitude	4-19
Calculate distance and time for a flight plan.	4-16
Calculate distance, bearing, and time from waypoint to waypoint	4-15
Calculate fuel requirements for a flight plan.	4-18
Calculate fuel requirements from waypoint to waypoint.	4-16
Calculate the pressure altitude	4-18
Calculate true airspeed (TAS)	4-20
Calculate winds aloft.	4-21
Cancel Direct To operation	3-34
Change a cyclic field.	3-15
Change navigation modes	4-26
Change the default first waypoint character.	3-13
Change the NAV 2 page present position reference waypoint . .	3-38
Create a flight plan	4-2
Create a user-defined waypoint at your present position.	4-22
Create a user-defined waypoint using the radial/distance method	4-24
Create a user-defined waypoint with latitude/longitude	4-23
Cycle between distance and desired track display on a numbered flight plan page	4-4
Cycle between distance, ETE, ETA, and desired track on the FPL 0 page	4-13
Delete a flight plan which is no longer required	4-6
Delete a user-defined waypoint from the OTH 3 page.	3-59
Delete a waypoint from a flight plan	4-6

<u>TO:</u>	<u>SEE PAGE:</u>
Delete a waypoint remark from the OTH 4 page	3-60
Display the nearest airport continuously.	3-28
Enter a user-defined waypoint remark on the SUP 3 page	3-54
Enter a waypoint identifier	3-12
Enter an airport remark on the APT 5 page	3-50
Enter the local magnetic variation manually on the SET 2 page .	4-30
Fly Direct To a waypoint	3-33
Fly direct to a waypoint in the active flight plan (FPL 0).	4-12
Initialize the position from the SET 1 page.	3-18
Recenter the D-Bar by going direct to the active waypoint	3-34
Select a VOR or NDB by navaid name	3-23
Select a waypoint by identifier from a waypoint page	3-20
Select a waypoint by scanning with the cursor off	3-22
Select a waypoint by scanning with the cursor on	3-22
Select an airport by scanning the airport name	3-24
Set the date on the SET 2 page	3-55
Set the time on the SET 2 page	3-56
Specify the nearest airport criteria	3-27
Store the active flight plan as a numbered flight plan.	4-7
Tune a 25 kHz COMM frequency.	5-2
Tune a COMM frequency	5-1
Tune a COMM frequency from the data base	5-3
Tune a COMM frequency using active frequency entry mode.	5-2
Tune a COMM frequency using standby frequency entry mode	5-1
Turn on and initialize the KLX 135A	3-2
Update the KLX 135A data base	2-5
View a message	3-16
View the waypoints in the flight plan that are not the active waypoint.	4-11

KLX 135A SYSTEM

—— REQUIRED
 OPTIONAL

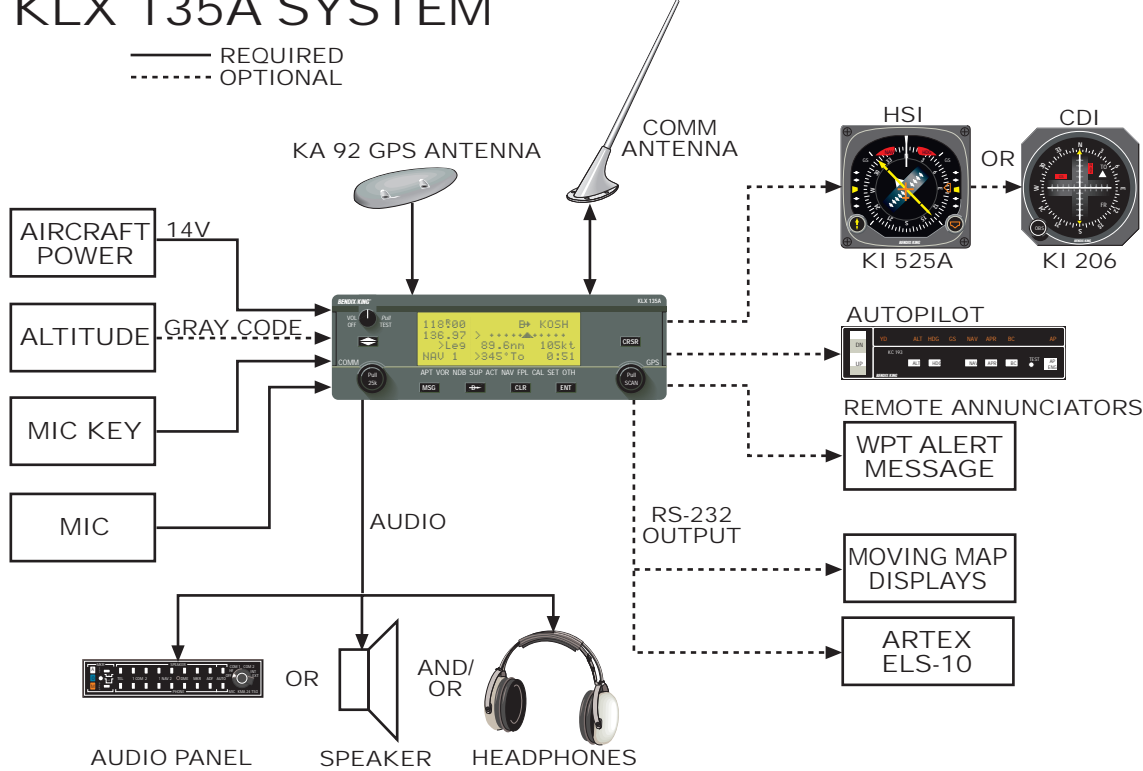

1. KLX 135A SYSTEM COMPONENTS

A basic KLX 135A system consists of a panel mounted KLX 135A GPS and a KA 92 GPS antenna. An altitude input is required to obtain full navigation and operational capabilities. Additional system components may be added or interfaced to the KLX 135A which increase its features and capabilities. Some of these optional components include an external course deviation indicator (CDI) or horizontal situation indicator (HSI), ARTEX ELS-10 emergency locator transmitter (ELT), autopilot, and external annunciators.

The KLX 135A panel mounted unit contains the GPS sensor, the navigation computer, a COMM transceiver, a liquid crystal display (LCD), and all controls required to operate the unit.

Installation of an appropriate VHF communication antenna (capable of transmitting and receiving 118.000 to 136.975 MHz) is required. However, the VHF COMM antenna is not included as part of the KLX 135A system.

A KA 92 GPS “patch” antenna is available for use with the KLX 135A. It is designed to always be mounted on the top of the aircraft.

The KLX 135A has analog outputs to drive the left-right deviation bar of most mechanical CDIs and HSIs. In addition, the NAV mode of the Bendix/King KFC 150, KAP 150, KAP 150H, KAP 100, KFC 200, KAP 200, KFC 250, KFC 275, KFC 300, and KFC 325 flight control systems may be coupled to the KLX 135A. Many other autopilots may also be coupled to the KLX 135A. Actual autopilot performance and capability when coupled to the KLX 135A may vary significantly from one autopilot model to another.

Altitude may be provided to the KLX 135A from an encoding altimeter or blind encoder. Altitude is used as an aid in position determination when not enough satellites are in view.

Some installations may require remote annunciators to be mounted in the aircraft panel in order to indicate the status of certain KLX 135A functions, namely waypoint alert and message.

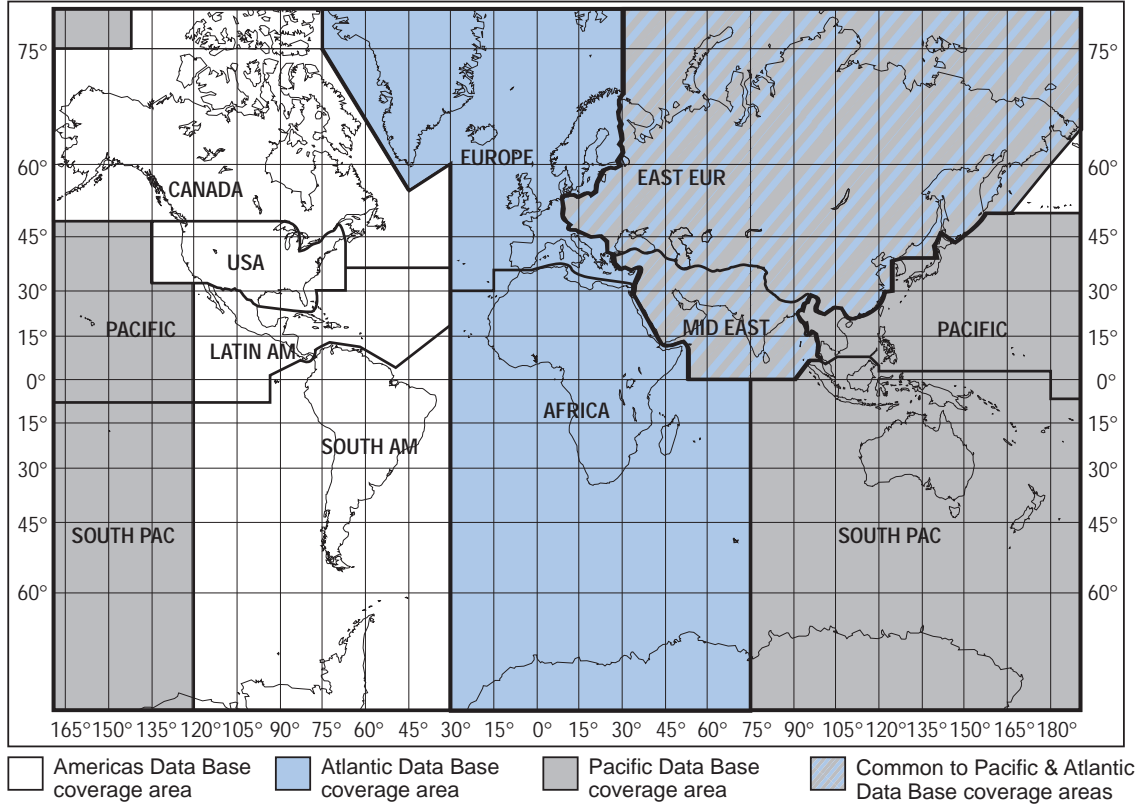

Figure 2-1 KLX 135A Data Base Geographical Region

2. DATA BASE

2.1. DATA BASICS

The data base provides two primary functions. First, it makes pilot interface with the GPS sensor much easier. Rather than having to manually look up and then enter the latitude and longitude for a specific waypoint, it allows you to merely enter a simple waypoint identifier. The data base automatically looks up and displays the latitude and longitude associated with the identifier. It should be obvious that the data base saves a lot of tedious latitude/longitude entry and also greatly reduces the potential for data input mistakes.

The second function of the data base is that it serves as a very convenient means to store and easily access aeronautical information. Want to know the name of the airport, the nearest city, or the airport altitude? Just unleash the power of the KLX 135A and display the information right on the screen.

2.2. DATA BASE CONTENTS AND COVERAGE AREAS

There are three data base coverage areas available for the KLX 135A. They are referred to as the "Americas" data base, the "Atlantic" data base, and the "Pacific" data base.

The International Civil Aviation Organization (ICAO) and Aeronautical Radio, Inc. (ARINC) break the world into the ten geographic regions shown in figure 2-1. The KLX 135A Americas data base contains aeronautical information for the group of ICAO regions consisting of Canada, USA, Latin America, and South America. The KLN 35A Atlantic data base provides information for the ICAO regions of Europe, Africa, East Europe, and Mid East. Likewise, the Pacific data base provides information for East Europe, Mid East, Pacific and South Pacific.

All three data bases contain complete information for all VORs and NDBs in their respective coverage area. The data base also contains public use and military airports which have any runway at least 1000 feet in length.

The following is a listing of the KLX 135A data base contents:

AIRPORTS

Identifier

Name

City, State or Country

Use type (if military)

Latitude and Longitude

Elevation

Runway numbers, lengths, surfaces, and lighting

Communication frequencies

VORs

Identifier

Name

Frequency

Latitude and Longitude

Magnetic variation

NDBs

Identifier

Name

Frequency

Latitude and Longitude

(Note - Outer Compass Locators are not included in the data base)

250 USER DEFINED WAYPOINTS

Identifier

Latitude and Longitude

MISCELLANEOUS

Air Route Traffic Control Center (ARTCC and FIR) frequencies

Flight Service Stations (location of points of communication and associated frequencies)

Special Use Airspace (SUA) boundaries (Prohibited, Restricted, Alert, Class B, Class C, CTA, TMA, TRSA)

2.3. ICAO IDENTIFIERS

Waypoints are stored in the KLX 135A data base almost exclusively by their ICAO identifiers. ICAO (International Civil Aviation Organization) is an internationally accepted reference for the data. In almost all cases the proper ICAO identifiers may be taken directly from Jeppesen Sanderson or government aeronautical charts.

Airport identifiers in the contiguous United States, Alaska, and Canada are special cases in the ICAO system. Many airport identifiers for these areas have four letters beginning with a prefix letter that corresponds to the geographic area in which it is located. The prefix letter for the contiguous U.S. is "K". Thus, the identifier for Dallas/Fort Worth International Airport is KDFW, not DFW (which would be identical to the VOR identifier). Likewise, the identifier for Orlando Executive Airport is KORL while the VOR identifier is ORL. The prefix letter for Canada is "C" and for Alaska is "P".

NOTE: *There are several exceptions in Alaska. In many cases, airports with three letter identifiers receive the prefix "P", but there are many that don't. The most reliable method of determining an Alaska airport identifier is to look it up from the airport name or city. See section 3.7.4, "Selecting Waypoints by Name or City".*

Incidentally, you can program the KLX 135A to default to a certain letter (such as "K") when you are entering a waypoint identifier. See section 3.4.2, "Data Entry" to learn about this handy feature.

Not all airport identifiers receive the prefix letter. Airport identifiers which are combinations of letters and numbers do not apply to the prefix rule. Examples of airport identifiers not using the prefix are 3C2, 7TX6, and M33.

So remember, if you are entering or looking for an airport identifier that is all letters (no numbers) then it will begin with a "K" prefix in the contiguous U.S., a "P" in Alaska (in some cases), or a "C" in Canada. If there are numbers in the identifier then a prefix is not used. For other areas of the world the airport identifier stored in the KLX 135A data base is identical to how it is charted.

2.4. UPDATING THE DATA BASE

The information stored in the data base would eventually become obsolete if there wasn't some means to update it. For example, new airports open, nav aids can move or change frequency, communication frequencies can change, and on and on.

The data base is updated by means of a 3.5-inch diskette supplied by AlliedSignal and an IBM-compatible personal computer. This method does not have to involve removing the KLX 135A from the aircraft's instrument panel. A jack, usually mounted in the aircraft's instrument panel, provides a means of interfacing the KLX 135A with the computer via an interface cable. The diskettes are not returned to AlliedSignal.

Every 28 days, AlliedSignal receives new NavData™ information from Jeppesen Sanderson. This information is processed and downloaded onto diskettes. AlliedSignal makes the update service available to you in a choice of several subscription or random update programs. See section 2.6 for details on these programs.

NOTE: *AlliedSignal sends the update so that it arrives prior to the next effective date. The new update may be installed any time prior to the effective date and the KLX 135A will use the previous data up to the effective date and automatically begin using the new data on the effective date.*

In order to use the update program you must have access to a computer having a disk drive capable of utilizing 3.5-inch 1.44 megabyte high density diskettes. This computer also needs to have an available COM 1 or COM 2 serial port. If you wish to perform updates in the cockpit, an optional PC Interface kit must be used. Included in the kit is an interface cable that plugs into both the computer and into the data loader jack. The data loader jack is included with the KLX 135A installation kit and is typically installed in the aircraft's instrument panel.

CAUTION: **The data base must be updated only while the aircraft is on the ground. The KLX 135A does not perform any navigation function while the data base is being updated. Since a data base update takes approximately 10 minutes it is a good idea to turn off all electrical equipment on the aircraft except for the KLX 135A to avoid running down the aircraft battery.**

NOTE: The diskettes sent to you can only be used to update one KLX 135A, although they can update that specific unit numerous times. The first time the diskettes are used in an update operation, a unique identification code from the KLX 135A being used is uploaded to the diskettes. These diskettes may be used in this specific KLX 135A an unlimited number of times which could be required if you switch back and forth between the Americas, Atlantic, and Pacific data bases during one update cycle. These diskettes may not, however, be used to update other KLX 135As. This update protection ensures that Jeppesen Sanderson is properly compensated for the use of their NavData™.

To update the KLX 135A data base:

1. Plug the 9 pin female connector end of the interface cable into a COM serial port of the computer. If the computer has COM 1 and COM 2 serial ports, either may be used. Some computers use a 9 pin COM serial port connector while other computers use a 25 pin connector. If the computer being used has a 9 pin connector, the interface cable connector will plug directly into the computer's 9 pin connector. If the computer's COM serial port uses a 25 pin connector, use the 25 pin to 9 pin adapter included in the PC interface kit to adapt the interface cable's connector to the computer's connector.
2. If you are using the PC interface kit in the cockpit, plug the other end of the interface cable (4 conductor male connector) into the data loader jack that is mounted in the aircraft panel.
3. Insert the diskette into the computer's disk drive. Turn on the computer being used for the data base update. The program on the disk will automatically "boot" (load) and the computer screen will display "Ready" when the computer is ready to continue with the data base update operation.

4. Turn on the KLX 135A. Press **ENT** as required to approve the Self Test, Initialization, VFR, and Data Base pages. Use the right outer knob to select the Setup (SET) type pages and the right inner knob to select the SET 3 page (figure 2-2).

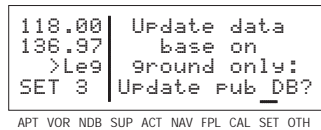

Figure 2-2

5. Press **CRSR**. **Update Pub DB?** will now be inverse video as in figure 2-3.

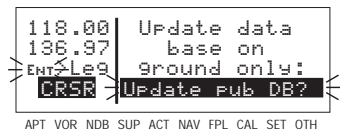

Figure 2-3

- Press **ENT**. The estimated load time in minutes is now displayed (figure 2-4).

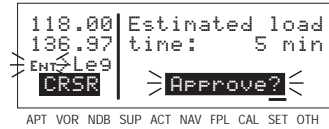

Figure 2-4

NOTE: In step 6, repeatedly pressing **CLR** will terminate the update process and bring the display back to the original SET 3 page shown in figure 2-2.

- Press **ENT** to acknowledge the estimated load time and begin erasing the existing data base. The unit will now display **Erasing data base**. After the data base has been erased, the loading of the new data automatically begins. As the new data is being loaded, the percentage of transfer is displayed (figure 2-5).

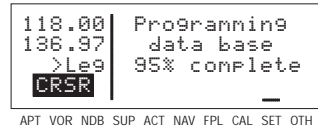

Figure 2-5

- The KLX 135A will indicate when the data base update is complete as shown in figure 2-6. You may either turn the KLX 135A off at this point or press **ENT** to restart the KLX 135A.

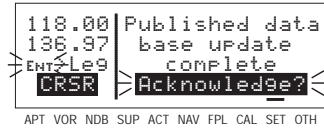

Figure 2-6

- Remove the interface cable. Remove the disk from the computer. Turn off the computer.

The chances are small of having difficulty updating the data base but—

If you have a problem:

- First check that the interface cable is properly connected and that the computer is turned on. If there is a problem with the connection or the computer the KLX 135A will display **Data Loader Not Ready**. When the problem is corrected this prompt is removed and the update operation can continue from where it left off.
- If an internal test fails after the data has been loaded, the KLX 135A will display **Checksum Error, Data Base Invalid**. Press **ENT** to acknowledge. The KLX 135A will then display **Data Base Update Failed, Retry?** Use the right outer knob to position the cursor over the desired choice and press **ENT**.

- There are other error messages that may be displayed. If you have a problem that you can't resolve, write down any error messages to aid your AlliedSignal Service Center in identifying the problem.

2.5. USER DEFINED DATA BASE

In addition to the published data base of airports, VORs, and NDBs stored in the Jeppesen data base, you may create up to 250 other user-defined waypoints. Section 4.4, "Creating User-defined waypoints" describes this further.

The KLX 135A contains an internal lithium battery that is used to "keep-alive" the user-defined data base as well as flight plans. This battery has a typical life of three to five years. *It is highly recommended that the battery be replaced every three years at an authorized AlliedSignal Service Center.*

2.6. DATA BASE UPDATE SERVICE OPTIONS

The following tear-out page can be used for ordering the Americas, Atlantic, and Pacific data base update services from AlliedSignal. The forms may be mailed or FAXed for your convenience.

This page intentionally left blank

**KLX 135A Data Base Update Service Order Form
Consult Pricing Sheet (006-08794-0001) for Service Prices**

AlliedSignal CAS offers several update service options to suit your requirements. Please select the service desired, then fill out and mail this order form. Credit card orders may be faxed.

Note: Updates are current for 28 days after effective date on diskette. If you select any service other than the complete 13-time service, your KLX 135A will begin alerting you after 28 days that your data base is out of date.

Diskette Format Only

(Laptop Computer Required. See section 2 of KLX 135A Pilot's Guide for details.)

Check Requested Data Base:

- Americas Data Base**
- Atlantic International Data Base**
- Pacific International Data Base**

Check One:

- Complete Update Service.** Provides 13 updates—one every 28 days for one year.
- Six-time Update Service.** Provides six updates—one every 56 days for one year.
- Four-time Update Service.** Provides four updates—one during each quarter for one year.
- Single Update.** Provides one update upon receipt of order.

Please set up the service under:

Name: _____
Company: _____
Address: _____
City: _____
State: _____ Zip Code: _____
Country: _____
Telephone: (____) _____
FAX: (____) _____
Aircraft Make: _____
Aircraft Model: _____

Method of Payment

- Check/Money order enclosed
- Wire Transfer:
Chase Manhattan Bank, NY
Acct #910-2-538734
- MasterCard/VISA

Number _____
Expires _____
Signature _____

**Tax may apply in some states.
See pricing sheet.**

Send to:

AlliedSignal CAS
Data Base Update Service
Mail Drop #66
400 N. Rogers Road
Olathe KS 66062-1212
Telephone: (913) 768-3020
FAX: (913) 768-3904



Tape here

Fold here

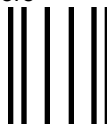

NO POSTAGE
NECESSARY
IF MAILED
IN THE
UNITED STATES

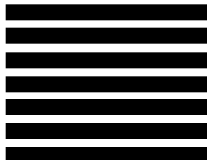

BUSINESS REPLY MAIL
FIRST-CLASS MAIL PERMIT NO. 121 OLATHE, KANSAS

POSTAGE WILL BE PAID BY ADDRESSEE

ALLIEDSIGNAL COMMERCIAL AVIONICS SYSTEMS
M D 66
400 NORTH ROGERS ROAD
OLATHE KS 66062-9987



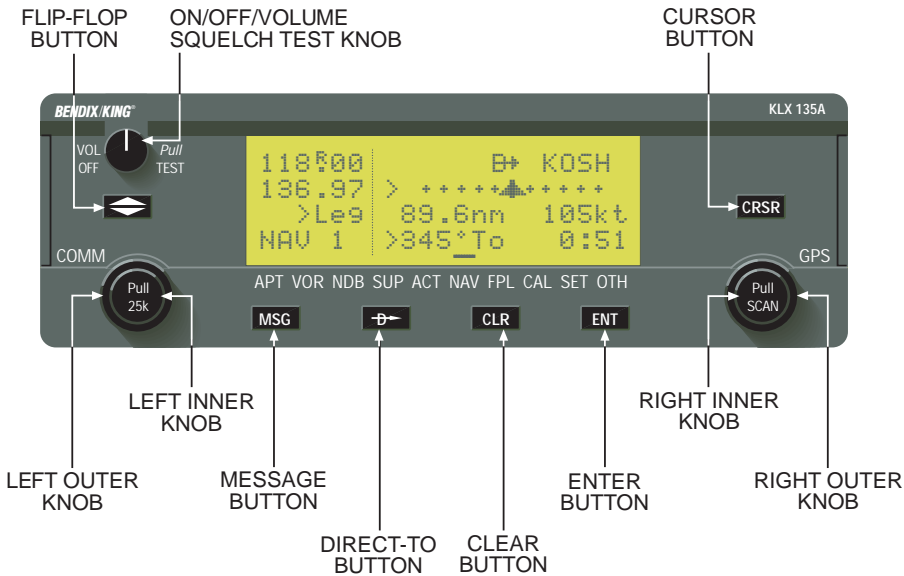

Figure 3-1 KLX 135A Controls

3. BASIC GPS OPERATION

3.1. COVERAGE AREA

The KLX 135A was designed to provide worldwide navigation coverage from North 74° latitude to South 60° Latitude (figure 3-2). Outside this area, magnetic variation must be manually entered as discussed in section 4.6, "Operation Outside the Primary Coverage Area". See section 2.2 for the data base geographical regions.

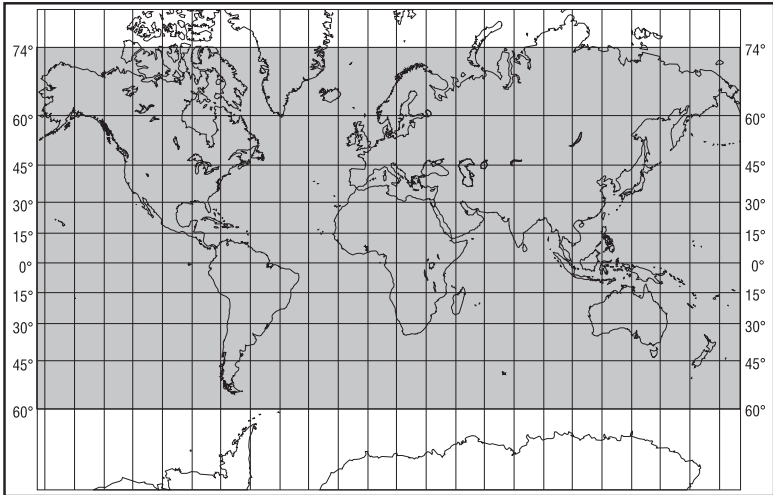

Figure 3-2 KLX 135A Navigation Coverage Area

3.2. TURN-ON AND SELF TEST

Well, it's time to get down to business and actually use the KLX 135A! Figure 3-1 can be folded out and used as a reference during the following procedures. This is especially handy if you're learning while away from your GPS. The steps below take a lot of words to explain, but before you know it, you will be "flying" through them.

NOTE: When power is applied to the KLX 135A it always "wakes up" in the En route-Leg mode. Only the En route-Leg mode is described in this chapter. In this mode the KLX 135A performs great circle navigation (the shortest distance between two points located on the earth's surface). The course deviation output displayed on the unit's internal course deviation indicator (CDI) and provided to an external horizontal situation indicator (HSI) or CDI is five nautical miles (full scale sensitivity) left and right. The other mode is En route-OBS and is described in section 4.5.3.

To turn on and initialize the KLX 135A:

1. Turn on the KLX 135A by turning the small power/volume knob clockwise. Be conscious of how far you turn it, for you are also adjusting the COMM volume.

The Turn-On page (figure 3-3) will be displayed for a few seconds. During this time, the KLX 135A performs an extensive internal test. The operational revision status (ORS) level number in the upper right corner of the display should match the ORS level indicated on the cover of this Pilot's Guide .

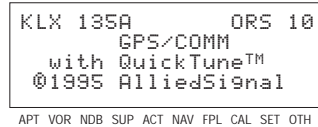

Figure 3-3

When the internal test is complete, the Turn-On page will automatically be replaced by the Self Test page (figure 3-4).

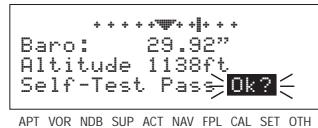

Figure 3-4

NOTE: If the KLX 135A is operating in the Take-Home Mode, the Take-Home Warning Page (figure 3-5) is displayed first and must be acknowledged by pressing **ENT**. See section 4.7 for more information on the Take-Home mode.

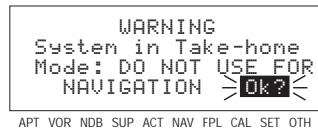

Figure 3-5

2. Verify that the data displayed on the Self Test page is the same as is being displayed on the appropriate indicator (if any) in the aircraft which is interfaced to the KLX 135A. If the KLX 135A is not connected to any other equipment in the aircraft, you may skip to step 3.

If the KLX 135A is interfaced with a NAV indicator such as an HSI or a course deviation indicator (CDI), the deviation bar (D-bar) should be indicating a half scale deviation to the right. The TO/FROM indicator should be showing FROM.

If any of the above checks fail, do not use the associated indicator with the KLX 135A.

3. If the KLX 135A has passed the internal self test, the bottom of the Self Test page will display **Pass** and all external annunciators should be illuminated. If instead, **Fail** is displayed, recycle power to the KLX 135A. If the Self Test page still displays **Fail**, the KLX 135A requires repair and should not be used for navigation.

- When you are ready to approve the Self-test page, press the **ENT** button while the **Ok?** is flashing. If it happens not to be flashing, press the **CRSR** button and use the right outer knob to move the cursor there.

- The next page displayed will be the Initialization page (figure 3-6). Verify that the date displayed in the top left corner of the Initialization page is correct. The KLX 135A has an internal battery powered calendar/clock, so the date and time normally don't require setting. The battery has a life of approximately 3 years. In addition, the KLX 135A's system date and time are automatically updated very precisely when at least one satellite is being received. However, if for some reason the date or time are incorrect, it is necessary to enter the correct date or time so that the KLX 135A can reach the navigation mode. The date must be correct and the time must be correct within ten minutes so that the KLX 135A will start looking for the correct satellites.

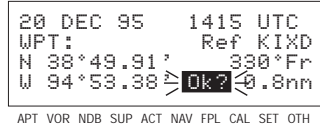

Figure 3-6

If the date is incorrect, rotate the right outer knob counterclockwise until the cursor is over the entire date field (figure 3-7). Rotate the right inner knob until the correct day of the month is displayed (figure 3-8). Then, move the cursor to the month field by rotating the outer knob one click clockwise and change the month as necessary. Use the same methods to select the correct year (figure 3-9). When the date is correct, press **ENT**.

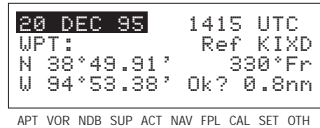

Figure 3-7

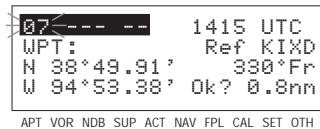

Figure 3-8

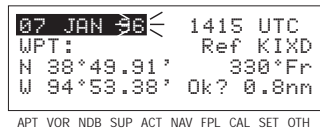

Figure 3-9

- Verify that the time displayed in the upper right corner of the Initialization page is correct to within ten minutes of the actual time. Remember, once the KLX 135A receives the first satellite, it will automatically be very accurately updated by the satellite to the correct time. However, you are responsible for assuring the

desired time zone is selected on the KLX 135A. If it is necessary to reset the time, position the cursor over the time zone field (figure 3-10) and select the desired time zone (figure 3-11).

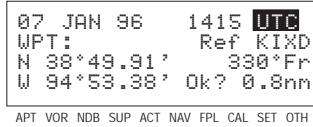

Figure 3-10

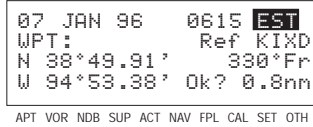

Figure 3-11

The following are the time zones which the KLX 135A is capable of displaying:

- UTC** Coordinated Universal Time (Zulu)
- GST** Greenland Standard Time (UTC - 3)
- GDT** Greenland Daylight Time (UTC - 2)
- ATS** Atlantic Standard Time (UTC - 4)
- ATD** Atlantic Daylight Time (UTC - 3)
- EST** Eastern Standard Time (UTC - 5)
- EDT** Eastern Daylight Time (UTC - 4)
- CST** Central Standard Time (UTC - 6)
- CDT** Central Daylight Time (UTC - 5)
- MST** Mountain Standard Time (UTC - 7)
- MDT** Mountain Daylight Time (UTC - 6)
- PST** Pacific Standard Time (UTC - 8)
- PDT** Pacific Daylight Time (UTC - 7)
- AKS** Alaska Standard Time (UTC - 9)
- AKD** Alaska Daylight Time (UTC - 8)
- HAS** Hawaii Standard Time (UTC - 10)
- HAD** Hawaii Daylight Time (UTC - 9)
- SST** Samoa Standard Time (UTC - 11)
- SDT** Samoa Daylight Time (UTC - 10)
- LCL** Local Time Zone (user-defined)

You will be able to change the time zone any time you desire on several other pages, so don't worry if you're not sure which time zone to choose. UTC—Coordinated Universal Time (also called "Zulu") is always a safe choice.

The local time zone (**LCL**) is selected on the SET 2 page, and is defined to be a certain time offset from Zulu (UTC).

Once you have selected the desired time zone, position the cursor over the entire time field and select the correct hour with the right inner knob (figure 3-12). Since 24 hour time is used, be sure to add 12 if the time is after 1:00 P.M. (2:30 P.M. becomes 1430). Now move the cursor to the tens of minutes position and select the desired value, and repeat this process for the last digit of the time field. When the correct time has been entered (figure 3-13), press **ENT** to start the clock running. Don't worry that you can't update the seconds. The KLX 135A system time will automatically be corrected very precisely once a satellite is received.

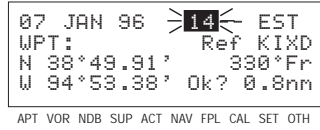

Figure 3-12

7. To aid the GPS receiver in acquiring your position, it is vital that it have a reasonable idea of where you are, and the Initialization page is where you have the chance to set this initial position. Check to see if the displayed initial position is where you actually are. This latitude/longitude is the last known position before the power was shut down the last time. Unless the unit has been moved since its last use, this position should be correct. On the right side of the screen will be the identifier of the nearest airport in the data base, with a radial and distance from that airport. If you need to change the initial position to—let's say—John F. Kennedy International (KJFK), move the cursor to the **WPT:** field and use the right inner knob to select a K as the first character of the identifier (figure 3-14). Move the cursor to the right one character and select a J and then right again to select an F. The final K should be filled in by the data base (figure 3-15). When you press **ENT**, the latitude and longitude fields will change to

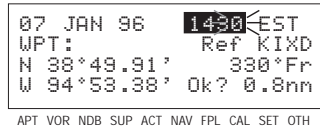

Figure 3-13

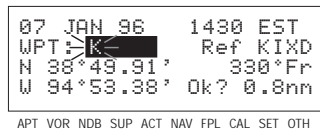

Figure 3-14

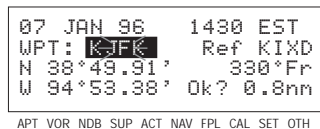

Figure 3-15

those of KJFK (figure 3-16). If necessary, the latitude and longitude may be entered manually.

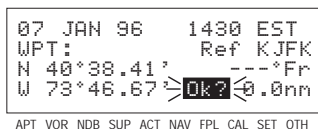

Figure 3-16

8. When all information on the Initialization page is correct, move the cursor to **Ok?** and press **ENT** to move on.
9. The VFR page will be displayed to notify you that the GPS is for VFR use only.
10. The Data Base page will now be displayed with the cursor over **Acknowledge?**. Line 1 indicates whether an Americas, Atlantic, or Pacific data base is being used. If the data base is current, line 3 will show the date when the data base expires (figure 3-17). If, on the other hand, the data base is out of date, line 3 shows the date that it expired (figure 3-18). The KLX 135A will still function with an out of date data base; however, you must exercise extreme caution and always verify that the data base information is correct before using information from an out-of-date data base. Press **ENT** to acknowledge the information on the Data Base page.

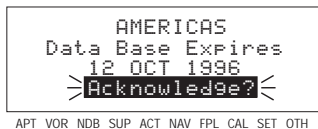

Figure 3-17

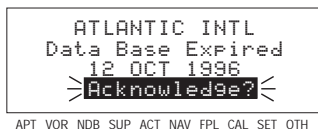

Figure 3-18

WARNING: The accuracy of the data base information is assured only if the data base is current. Operators using an out-of-date data base do so entirely at their own risk.

A waypoint page for the waypoint which was active when the KLX 135A was last turned off will be displayed on the screen. If the last active waypoint was an airport, the APT 4 page showing the airport's communications frequencies will be displayed (figure 3-19). We thought you'd like that! Almost always, the waypoint which was active when you last turned the KLX 135A off is the airport where you landed. Therefore, when you get ready to depart, the airport communication frequencies for that airport will automatically be displayed for you! If you wish to select one or two of the airport frequencies to QuickTune™ the COMM, see section 5.1.5, "Using QuickTune™ Frequency Selection".

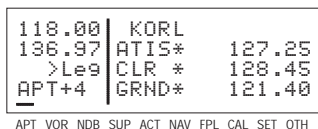

Figure 3-19

Next, you'll probably want to check the NAV 2 page to see your present position. Use the right outer knob to select the NAV page type and then the right inner knob, if necessary, to select the NAV 2 page. It is quite likely that the present position will be dashed at first (figure 3-20). It takes the KLX 135A several minutes to acquire the GPS satellites and to make its initial calculation of your position. When the KLX 135A reaches a NAV ready status and is able to navigate, the NAV 2 page will display your present position relative to the nearest VOR (figure 3-21). Verify that the present position shown on the NAV 2 page is correct.

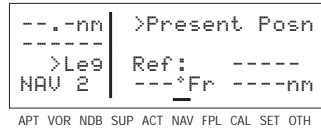

Figure 3-20

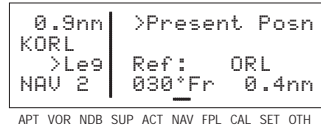

Figure 3-21

NOTE: In order to reach a Nav ready status, the aircraft must be away from obstructions blocking the GPS antenna's view of required satellites. If the KLX 135A fails to reach a Nav ready status within five minutes refer to section 3.6, "Initialization And Time To First Fix".

3.3. DISPLAY FORMAT

The KLX 135A uses a Liquid Crystal Display (LCD). In normal operation, the display screen is divided into two segments by a vertical line, called the page divider. In some cases, such as the display of system messages or the turn-on and self test sequence, the page divider disappears and you have a "full-screen" page (figure 3-22).

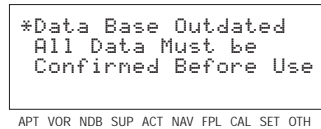

Figure 3-22

Aeronautical information (or *data*) is presented on the screen in the form of "pages". A page is a presentation of specific data in an organized format. Various page "types" are used to display related kinds of data. For example, one page type is NAV (navigation). NAV pages show information such as distance, groundspeed, bearing, course, and other data relating to navigation. Another page type is APT (airport). APT pages contain information pertinent to a specific airport such as name, city, State, elevation, and direction and distance relative to the aircraft's present position.

In normal operation, the aeronautical data is displayed on the right side of the screen. The active and standby COMM frequencies appear in the upper left corner of the display, The active frequency is

always on the top line. The bottom line on the left side of the page divider indicates the page type that is being displayed on the right side of the page divider. In figure 3-23, the **APT 1** (airport 1) page is being displayed.

```

118.00 | KISM
136.97 | KISSIMMEE MUN
>Leg  | ORLANDO
APT 1  | FL
-----
APT VOR NDB SUP ACT NAV FPL CAL SET OTH
    
```

Figure 3-23

You might think of the page types as the chapters in a book and the page numbers as the pages within a chapter. Just as a chapter in a book may have from one to many pages, a KLX 135A page type may have from two to 10 pages associated with it. There are, for example, 10 flight plan pages (FPL 0, FPL 1, FPL 2, ..., FPL 9) in the flight plan page type and five airport pages (APT 1, APT 2, APT 3, APT 4, APT 5) in the airport page type.

Figure 3-24 shows an example of an APT 4 page. Notice the “+” sign in the page identification. Whenever a “+” sign is part of a page identifier there will be two or more pages, all having the same page number, used to present all of the required information. That is, all of the information associated with a particular page number doesn’t fit on the page being viewed. In this case the “+” sign indicates that there are two or more APT 4 pages. Figure 3-25 shows the second APT 4 page for KICT (Wichita Mid-Continent Airport).

```

118.00 | KICT
136.97 | ATIS      125.15
>Leg  | CLR        125.70
APT+4 | GND        121.90
-----
APT VOR NDB SUP ACT NAV FPL CAL SET OTH
    
```

Figure 3-24

```

118.00 | KICT
136.97 | TWR        118.20
>Leg  | UNIC       122.95
APT+4 | CL C       126.70
-----
APT VOR NDB SUP ACT NAV FPL CAL SET OTH
    
```

Figure 3-25

The third line of the left side has three purposes: (1) If the KLX 135A is ready for you to approve something, such as a selected waypoint, the “Ent” prompt will flash (figure 3-26), indicating you should press the **ENT** button to continue. (2) If the KLX 135A has a new message for you which must be viewed on a message page, a large “M” will flash in the same area (figure 3-27) telling you to press the **MSG** button and view the new message. (3) Immediately to the right of the “message/enter” display area, the navigation mode (see section 4.5 for details) is displayed. If the KLX 135A is in the En route-Leg mode (the normal mode of operation), “Leg” will be displayed here.

```

118.00 | ZBU < 116.70
136.97 | BIMINI
>ENT Leg | N 25°42.10'
VOR 1  | W 79°17.10'
-----
APT VOR NDB SUP ACT NAV FPL CAL SET OTH
    
```

Figure 3-26

```

118.00 | M+ KSEA
124.62 | > ++++++
>M Leg | 62.1nm 112kt
NAV 1  | >262°To 0:33
-----
APT VOR NDB SUP ACT NAV FPL CAL SET OTH
    
```

Figure 3-27

The lower left corner of the display, where the page type and number are usually displayed, can also display short operational messages to the user called "scratchpad messages". These messages are displayed for approximately five seconds, then this area returns to the page type and number. Figure 3-28 shows an example of a scratchpad message indicating a duplicate identifier. A complete listing of scratchpad messages is available in Appendix C of this Pilot's Guide.

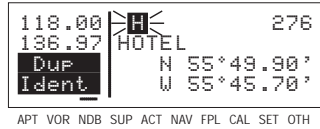

Figure 3-28

3.4. BASIC OPERATION OF PANEL CONTROLS

The KLX 135A controls are very easy to use. Most of the page selection and data entry is done with the knobs on the right side of the front panel and the cursor (CRSR) button immediately above them. The knobs on the left side and the flip-flop (⇄) button above them control the communication transceiver. There are four buttons across the bottom: MSG (Message), → (Direct To), CLR (Clear), and ENT (Enter). The operation of these buttons will be described on the next few pages.

The cursor is an area of inverse video (light characters on a dark background) on the screen. Many pages allow you to add, delete, or change data on the screen by first pressing the CRSR button to turn the cursor function on and bring the cursor on the screen. The right knobs are then used to enter or change data. When the cursor is on the screen, the lower left corner of the screen will show CRSR in inverse video rather than the page name for that particular page (figure 3-29). The cursor is over Present Posn.

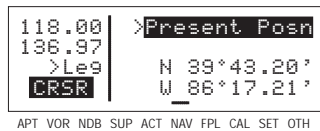

Figure 3-29

There are times when the cursor is flashing. Figure 3-30 shows an example of how "whiskers" are used in this Pilot's Guide to depict a flashing cursor (over ATIS 125.15) in addition, it shows an example of how "whiskers" around normal text is used to depict normal (non-inverse) characters flashing. The letters Ent are flashing but are not in inverse video.

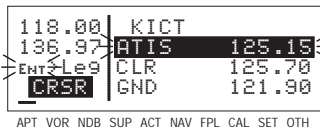

Figure 3-30

3.4.1. PAGE SELECTION

It is now time to learn to select a desired page.

NOTE: The cursor function is not used in selecting pages and the **CRSR** button should not be pressed at this time. If **CRSR** is annunciating in the lower left corner of the display, press the **CRSR** button to turn the cursor function off.

The right outer knob is rotated to select one of ten page types for the display. These ten page types are the following:

Chapter Name/ Page # Range	Page Type	Page Functions
APT 1-5	Airport	Directory of published airports
VOR 1-2	VOR	Directory of published VOR stations
NDB 1-2	NDB	Directory of published non-directional beacons (NDB)
SUP 0-3	Supplemental Wpt	Directory of user-defined waypoints
ACT *	Active Waypoint	Information about the active waypoint
NAV 1-5	Navigation	Navigation data
FPL 0-9	Flight Plan	Active and stored flight plans
CAL 1-6	Calculator	Distance, bearing, time and fuel calculator; air data calculations based on pilot-entered data
SET 1-8	Setup	Setting initial position and date/time, updating the data base, and selecting certain features
OTH 1-5	Other	Status reports, and deleting user wpts and remarks

*Varies with the type of waypoints in the active flight plan.

Remember that the page type is displayed at the lower left corner of the screen. The first three letters of the page type are always used for annunciation on the screen, for example, **CAL** represents Calculator page. The page type is also annunciated by means of a bar on the display, which moves as you turn the right outer knob. All the page types are listed across the front panel directly under the display, and the bar will always be over one of them. For example, let's say you were on an APT page

(figure 3-31) and you wanted to turn to a SET page. You would look at the list and see that the SET pages are eight places to the right of the APT pages. Therefore, turning the right outer knob eight clicks clockwise will get you to the SET pages (figure 3-32). The annunciator bar and the page labels work kind of like a map to get you from one page type to another. The page type selection wraps around from Other (OTH) to Airport (APT); that is, the knob has no mechanical stops.



Figure 3-31

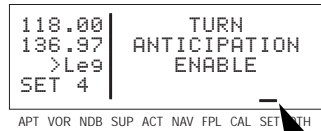

Figure 3-32

Once you have selected the desired page type using the right outer knob, you may select the page number by rotating the right inner knob. Let's use an example to make sure you understand. You are presently viewing the APT 2 page and you wish to view the NAV 3 page. Rotating the right outer knob 5 (five) clicks clockwise will display the NAV page that you last viewed—we'll say the NAV 2 page. Turning the right inner knob one click clockwise or three clicks counterclockwise will bring you to the NAV 3 page. Got it?

NOTE: In this Pilot's Guide the right smaller knob is assumed to be in the "in" position unless it specifically states that the knob should be in the "out" position. Therefore, the words "rotate the right inner knob" mean to turn the right inner knob while the knob is in the "in" position.

3.4.2. DATA ENTRY

Now that you've learned how to select the desired page, you're ready to learn the means of entering data. It is necessary to enter data, for example, in order to specify a waypoint of your choice to go Direct To. The general procedure for entering a waypoint identifier is described below and is shown in figures 3-33 through 3-41 for entering a waypoint (in this case, First Flight airport in North Carolina, identifier KFFA) on the Calculator (CAL) 1 page.

To enter a waypoint identifier:

1. If the cursor is not on the screen (figure 3-33), press **CRSR** to turn on the cursor function (figure 3-34).

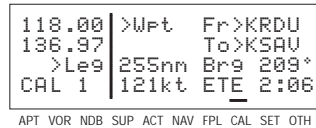

Figure 3-33

2. If required, rotate the right outer knob to position the cursor (figure 3-35).

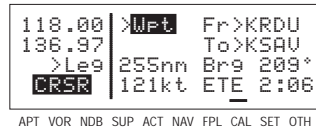

Figure 3-34

3. Rotate the right inner knob to select the first character of the waypoint identifier (figure 3-36).

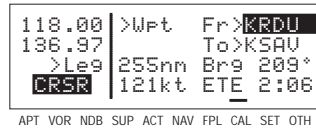

Figure 3-35

4. Turn the right outer knob one click clockwise to move the cursor to the second character position (figure 3-37).

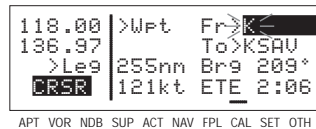

Figure 3-36

5. Rotate the right inner knob to select the second character (figure 3-38).

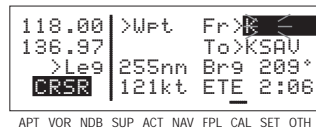

Figure 3-37

6. Use the right outer and inner knobs in this manner until the complete waypoint identifier is displayed (figure 3-39). Note that you may not have to enter the last characters of the identifier because each time you enter a character, the KLX 135A offers you the first identifier in the data base beginning with the characters you have entered.

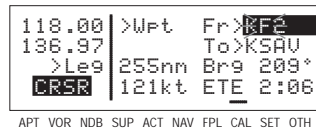

Figure 3-38

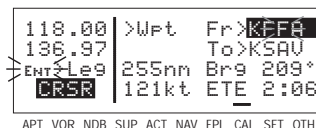

Figure 3-39

- If **Ent** is flashing on the left side of the screen, then press **ENT**. This will prompt the KLX 135A to display a waypoint page for the waypoint identifier you just entered (figure 3-40).

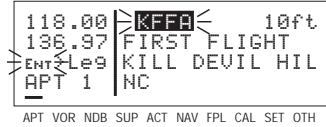

Figure 3-40

- Verify the waypoint information displayed, and then press **ENT** again to approve the waypoint page. The display will return to the page previously displayed (figure 3-41).

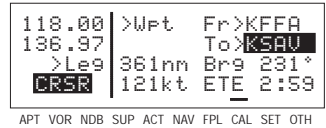

Figure 3-41

Often, you will find yourself entering airports that begin with the same character over and over again. In section 2.3, you learned how the KLX 135A uses ICAO identifiers, which means that many U.S. airport identifiers begin with the letter K. Also, many airport identifiers in Europe begin with the letter E or the letter L. Especially when flying VFR, you will mostly want to enter airports as Direct To or Flight Plan waypoints. The KLX 135A has a great feature that will save you turns of the knob when you know that the first character will probably be a K, E, L, or other letter that is commonly used in your part of the world. You can set the default first waypoint identifier character on the SET 5 page.

To change the default first waypoint identifier character:

- Select the SET 5 page (figure 3-42) and turn on the cursor (**CRSR**) (figure 3-43).

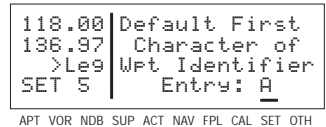

Figure 3-42

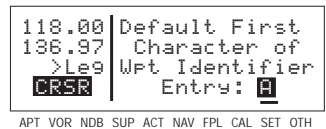

Figure 3-43

- Use the right inner knob to select the desired character (figure 3-44), such as a K in the U.S., a C in Canada, a P in Alaska, an E or an L in Europe, etc.

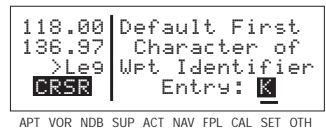

Figure 3-44

- Turn off the cursor. To try it out, proceed to the SET 1 page (initial position). Turn the cursor (CRSR) on (it will come on over the waypoint field). Try turning the right inner knob clockwise (figure 3-45). There's the character you just selected on the SET 5 page!

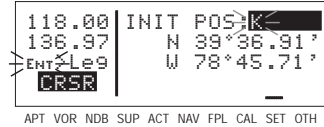

Figure 3-45

3.4.3. THE DUPLICATE WAYPOINT PAGE

There are some waypoints in the data base whose identifiers are not unique. That is, more than one waypoint has the same identifier. When a waypoint identifier has been entered which is not unique to a single waypoint, a Duplicate Waypoint page appears on the screen. The Duplicate Waypoint page is used to select which of the waypoints having the same identifier is actually desired. The waypoint identifier is displayed on the top left of the page. To the right of the identifier is the number of waypoints in the data base having the identifier. Below the identifier is a list of the waypoint types (APT, VOR, NDB, USR) and the associated countries which use the identifier.

To see an example of a Duplicate Waypoint page, try entering the identifier "D" as a Direct To waypoint or a Flight Plan Waypoint:

- Press **→**.
- Select the letter "D" as the waypoint identifier (figure 3-46). **D** is the full identifier of several waypoints in the KLX 135A data base.

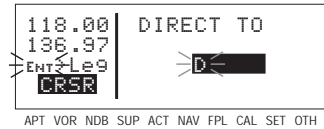

Figure 3-46

- Press **ENT**. The Duplicate Waypoint page will be displayed on the screen (figure 3-47). At the time of this writing, there were three waypoints in the Americas data base having the identifier **D**.

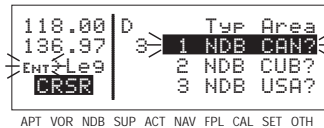

Figure 3-47

If there are more than four waypoints having the same identifier, only the first three are initially shown. The list includes an NDB in Canada, an NDB in Cuba, and an NDB in the U.S. The cursor will be over the first waypoint listed. They are listed with the waypoint closest to the aircraft's present position displayed first and the waypoint furthest from the aircraft displayed last. To view the rest of the choices,

rotate the right outer knob clockwise. Doing so will move the flashing cursor over waypoints two, three and then will cause the waypoint list to "scroll" so that the other waypoints in the list may be seen.

4. To select the desired waypoint, move the cursor over the appropriate choice (figure 3-48).
5. Press **ENT** and the display will change to the waypoint page for the selected waypoint (figure 3-49).
6. Press **ENT** again to approve the waypoint page.

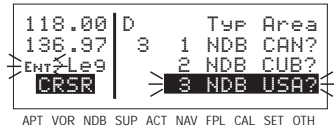

Figure 3-48

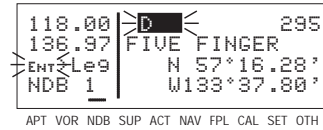

Figure 3-49

3.4.4. CYCLIC FIELDS

On many of the KLX 135A pages, there are *cyclic fields*, which are preceded by a carat (>). A cyclic field is one that you as the pilot can select from two or more options. For example, in figure 3-50, the field **>135°To** (magnetic bearing to Austin VOR) is a cyclic field. In this case, the second option is the magnetic radial from Austin VOR to present position.

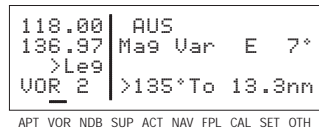

Figure 3-50

To change a cyclic field:

1. Turn on the cursor by pressing the **CRSR** button (figure 3-51).
2. Using the right outer knob, move the cursor over the cyclic field you wish to change (figure 3-52).
3. Press the **CLR** button to change the cyclic field (figure 3-53). Notice that repeated **CLR** presses "cycle" you through the choices. In this case there are only two, so **CLR** works like a toggle switch.



Figure 3-51



Figure 3-52

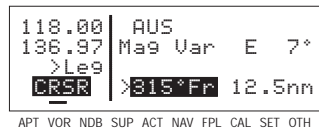

Figure 3-53

NOTE: The cyclic field which always appears on the left side of the display is the navigation mode selector/annunciator. In most cases, it will display >Leg indicating en route-leg mode (figure 3-53). The other choice is the en route-OBS mode, in which the magnetic selected course is displayed here (figure 3-54). You can move the cursor to this cyclic field by turning the cursor all the way counter-clockwise. See section 4.5 for more details on navigation modes.



Figure 3-54

3.5. MESSAGE PAGE

Whenever the KLX 135A wants to get your attention, the message prompt (a large “M” on the left side of the screen begins flashing (figure 3-55). If you have a remote message annunciator in your aircraft, it will also begin flashing at that time. You should view the message at your earliest opportunity because the unit may be alerting you to some situation of immediate concern to its condition or to your flight. A description of each possible message is included in Appendix B of this Pilot’s Guide.



Figure 3-55

To view a message:

1. Press the **MSG** button. The MSG page will appear and show the new message (figure 3-56).

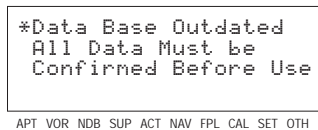

Figure 3-56

NOTE: Appendix B of this Pilot’s Guide contains a list of all the Message page messages and their meanings. It is possible that several messages are displayed at one time on the Message page. The newest message appears first and the rest in reverse chronological order.

2. After reading the message, press **MSG** again to return to the page previously in view. If all of the messages cannot be displayed on one Message page, repeated presses of **MSG** will show the other messages before returning to normal operation. If a message condition exists which requires a specific action by you, the message prompt will remain on but will not flash.

3.6. INITIALIZATION AND TIME TO FIRST FIX

Since the KLX 135A stores its position and other required parameters in memory when power to the unit is removed, it is seldom necessary to aid the unit in reaching a NAV ready condition. The time required from power on until the KLX 135A determines its present position and is therefore ready to navigate is called "time to first fix." The time to first fix is normally a few minutes or less. In order for the KLX 135A to reach a NAV ready condition, it is necessary to meet the following conditions:

1. The KLX 135A's "almanac" data must be current. Almanac data is orbital information for all the satellites and is used for initial acquisition when the KLX 135A is first turned on. This data is stored in the KLX 135A's non-volatile memory and is considered current for up to six months. Each satellite sends almanac data for all satellites. Since the KLX 135A routinely updates the almanac data during normal operation, the almanac data will become out of date only if the KLX 135A hasn't been used for the previous six months or longer. Collecting new almanac data takes place automatically if the data is more than six months old. The process of acquiring new almanac data is called a "Search The Sky" start-up. The Search The Sky process requires that the KLX 135A be turned on for a period of from 12.5 to 20 minutes and that at least one satellite be in view. The Self Test, Initialization, and Data Base pages should be approved. Almanac data is being collected as long as the Other 1 (OTH 1) page displays **SRCH** in the upper right corner. In addition, the message alert will flash indicating there is a message to be viewed. If you press the **MSG** button the message page will display a message stating:

***Search the Sky
Acquisition Started**

Press **MSG** again to return to the previous page. The message will remain active while the almanac data is being collected.

2. The aircraft must be located such that the GPS antenna has an unobstructed view of the sky so that required satellite signals are not being blocked. If possible, position the aircraft away from hangars or other obstructions.
3. The date and time displayed on the Initialization page or SET 2 page should be within 10 minutes of actual time. Date and time are seldom a practical concern because the KLX 135A contains

a battery backed up calendar/clock. In addition, once a satellite is being tracked, the KLX 135A's system time is automatically updated to UTC (Zulu) time. However, if the time displayed on the Initialization page or the SET 2 page is in error by more than 10 minutes it is necessary to enter a correct time. See steps 5 and 6 in section 3.2, "Turn-On And Self Test."

- The aircraft's position should be within 60 nm of where the KLX 135A last had a valid position. If the distance is greater than 60 nm the KLX 135A's position should be "initialized" on either the Initialization Page (section 3.2), or the SET 1 page. Since the KLX 135A stores its position when power is removed, it is usually not necessary to initialize the position when power is later reapplied. However, initialization may be required, for example, if the KLX 135A was not turned on for a flight or if it stopped navigating somewhere along the last flight or if it stopped navigating somewhere along the last flight due to a lack of adequate satellite coverage. If there is any doubt about whether or not to initialize, go ahead and do it! It's no big deal and it takes just a moment.

To initialize the position from the SET 1 page:

- If the cursor is not on the screen (figure 3-57), press the **CRSR** button to bring it on the page over the **INIT POS** field (figure 3-58).

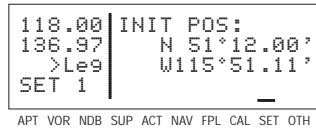

Figure 3-57

- Using the right inner and outer knobs, enter the identifier for the airport where you are presently located or the identifier of a navaid or other airport which is close to your present position (figure 3-59). Any waypoint in the data base which is within 60 miles is acceptable, but the closer the better. Remember, if you are entering an airport identifier that is all letters (no numbers), then it will begin with a "K" prefix in the contiguous U.S., a "P" in Alaska (in some cases; in others, the prefix is not added), or a "C" in Canada. If there are numbers in the identifier then a prefix is not used. Outside the contiguous U.S., Alaska, and Canada, use the airport identifiers as they are charted.

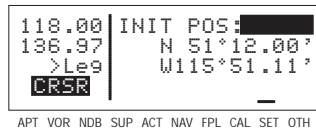

Figure 3-58

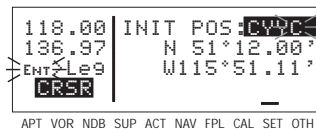

Figure 3-59

- Once you have entered the complete identifier, press **ENT**. The display will change to the waypoint page for the waypoint you entered (figure 3-60).



Figure 3-60

- If this is the waypoint you intended to enter, press **ENT** again. The display will change back to the SET 1 page.

NOTE: As an alternative, you can also enter the approximate latitude and longitude of your present position directly on the SET 1 page instead of entering a waypoint.

- With the right inner knob, position the cursor over **Ok?**, if it is not already there (figure 3-61).

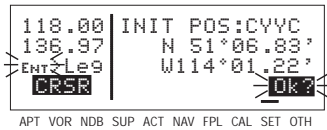

Figure 3-61

- Press **ENT** to approve the initial position. The cursor will automatically be removed from the screen.

NOTE: If the KLX 135A is in the Take-Home mode, you are allowed to enter the groundspeed (kt) and heading (°) fields in order to simulate flight (figure 3-62). They are not used for actual initialization in an aircraft. However, entering a ground speed will allow the KLX 135A to “fly” along the active flight plan (or to a direct to waypoint) starting from the initialization waypoint. A heading may be entered in the initial heading field while in the Take-Home mode if the one offered is not desired. See section 4.7 for more details on the Take-Home mode.

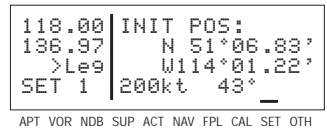

Figure 3-62

- Select the NAV 2 page. When the KLX 135A reaches the NAV ready status and is therefore able to navigate, the NAV 2 page will display the present position. Verify that the latitude and longitude or the waypoint, radial, and distance display of present position are correct.

3.7. SELECTING AND SCANNING WAYPOINTS

There are four types of waypoints: airports, VORs, NDBs, and user waypoints. Waypoints in the published data base fall into one of the first three types. You can create up to 250 user waypoints to supplement the waypoints in the database (see section 4.4 to create a user waypoint).

There are three methods you may use to select a specific waypoint for viewing. You may enter the waypoint's identifier directly, you may scan through the waypoint identifiers in alphabetical order, or you may enter the waypoint's name. If the waypoint is an airport, you may also select it by entering the city where the airport is located.

3.7.1. SELECTING WAYPOINTS BY IDENTIFIER

The most direct way of selecting a specific waypoint is to simply enter the waypoint's identifier directly on the appropriate waypoint page type (APT, for example). Let's use Chicago O'Hare International Airport whose identifier is KORD as an example.

To select a waypoint by identifier from a waypoint page:

1. Use the right outer and inner knobs to select the Airport 1 (APT 1) page (figure 3-63). (Actually, the airport identifier can be entered on any of the three Airport pages but we'll use the APT 1 since it displays the airport name and city).
2. Turn on the cursor (**CRSR**) and make sure the right inner knob is pushed in. The cursor will appear over the first character of the airport identifier (figure 3-64).
3. Turn the right inner knob to select a "K" as the first character (figure 3-65). You may turn the knob either clockwise or counterclockwise, and the letters and numbers wrap around with a blank character separating the "9" and the "A". Notice that as you turn through letters, the KLX 135A automatically fills in the identifier of the first waypoint in alphanumeric

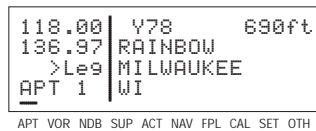

Figure 3-63



Figure 3-64

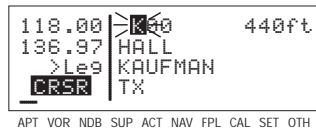

Figure 3-65

order in the data base which matches what you've entered so far (in this case, Hall Airport in Kaufman, Texas). Go ahead and experiment a little bit.

4. Use the right outer knob to move the cursor to the second character and select an "O" (figure 3-66).

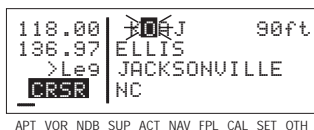

Figure 3-66

5. Use the same process to select an "R" and then a "D" (figure 3-67). You are now viewing the APT 1 page for **KORD**.



Figure 3-67

The KLX 135A feature of filling in characters of the identifier can be a time saver! For a second example, let's select Bloomington VOR whose identifier is **BMI**.

More selecting a waypoint by identifier:

1. Make sure you have turned the cursor off from the previous example. With the right knobs, select the VOR 1 page (figure 3-68).

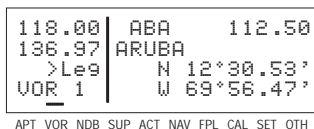

Figure 3-68

2. Turn the cursor (CRSR) on.
3. Change the first character to a "B" (figure 3-69).

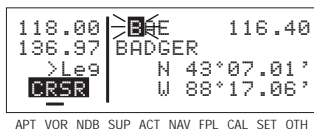

Figure 3-69

4. Move the cursor to the second character and select "M" (figure 3-70). Eureka! When you entered the "M", the KLX 135A searched its data base for the first VOR identifier beginning with the letters "BM" and found **BMI**. Many times you will only have to enter two or three characters of the waypoint identifier and the KLX 135A will furnish the rest.

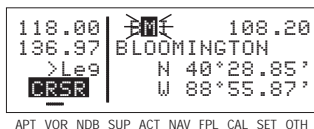

Figure 3-70

5. Turn off the cursor (CRSR).

3.7.2. SELECTING WAYPOINTS BY SCANNING

You may also select waypoints by scanning through them. This may be done with the cursor either on or off.

To select a waypoint by scanning with the cursor off:

1. Select the page type for the waypoint you are looking for (APT, VOR, NDB, or SUP).
2. Pull the right inner knob to the “out” position.
3. Turn the right inner knob clockwise to scan through the waypoints in alphabetical order, or counterclockwise to scan in reverse alphabetical order. Remember that numbers are considered lower in order than letters. Thus, the airport identifier **KA2** comes before **KA AF**.

NOTE: *The faster you turn the knob while scanning, the larger the step through the waypoints. This variable rate scanning allows you to get from one end of the list to the other very quickly. When the knob is turned slowly, you will go through the waypoints one at a time.*

You may also want to scan waypoints with the cursor on. This is especially useful if you remember the first part of the identifier, or if you wanted to scan all airports that start with a **KL**, for example. Let’s give it a try.

To select a waypoint by scanning with the cursor on:

1. Select the page type for the waypoint you are looking for (APT, VOR, NDB, or SUP). In this case, we want the APT 1 page.
2. Turn on the cursor (**CRSR**). It will appear over the first character of the waypoint identifier. Select a **K** with the right inner knob.
3. Move the cursor one place to the right and select an **L** (figure 3-71).
4. Move the cursor one place to the right and pull the right inner knob out. The last two characters of the waypoint identifier will be in reverse video (figure 3-72).
5. Use the right inner knob to leaf through all the data base airports whose identifiers begin with **KL**.



Figure 3-71



Figure 3-72

You will see **KL6**, Little Bear Lake Airport in Saskatchewan (figure 3-73), and **KLAS**, McCarran International in Las Vegas, Nevada among others.



Figure 3-73

3.7.4. SELECTING WAYPOINTS BY NAME OR CITY

When you know the identifier of the desired waypoint you will use one of the two methods just described to select it. However, what if you know the name but you don't know the identifier of your desired waypoint? You're in luck because the KLX 135A will allow you to enter the first few characters of the name to help you find it in the data base. We will use a couple of examples to illustrate how this is done. For VORs and NDBs, you may use the navaid name. For airports, you may use the airport name or the city name (where the airport is located).

In this first example we want to view the information in the KLX 135A data base for Napoleon VOR (located just east of Kansas City) but we don't remember the identifier for it.

To select a VOR or NDB by navaid name:

1. With the cursor off, use the right knobs to select the VOR 1 page (figure 3-74). The VOR waypoint in view is not important.
2. Press **CRSR** and then make sure the right inner knob is pushed to the "in" position.
3. With the right outer knob, move the cursor over the first character in the VOR name which is being displayed (figure 3-75).
4. Change this first character to an "N" in this case (figure 3-76).
5. Move the cursor one space to the

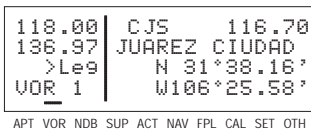

Figure 3-74

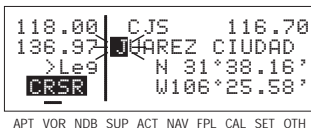

Figure 3-75

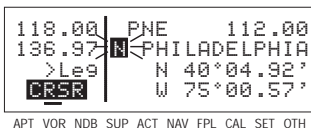

Figure 3-76

right and select the second character, "A" (figure 3-77).

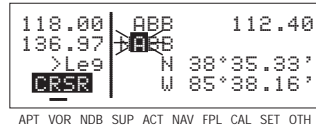

Figure 3-77

6. Select the third character, "P" (figure 3-78). Up pops Napoleon and its identifier, ANX!
7. Turn off the cursor (CRSR) so you can view other pages.

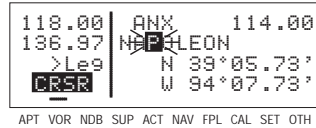

Figure 3-78

We will now use another example to show how we may enter a few characters and then scan through all the waypoints in the data base beginning with those characters. Let's use this method to find La Guardia Airport in New York City.

To select an airport by scanning the airport name:

1. With the cursor off and the right inner knob in the "in" position, select the APT (Airport) 1 page. The airport displayed at this time is not important.
2. Turn on the cursor (CRSR).
3. Move the cursor over the first character in the airport name (figure 3-79).
4. Change the first character to an "L".
5. Move the cursor one place to the right, and select an "A" (figure 3-80).
6. Now, move the cursor one place to the right and pull the right inner knob out. The rest of the airport name field will appear in inverse video (figure 3-81).



Figure 3-79



Figure 3-80



Figure 3-81

- Turn the right inner knob clockwise, scanning through La Crosse Municipal, La Grande/Union airport, and several others. Eventually, you will arrive at “**LA GUARDIA**” (figure 3-82). By turning the cursor off, pushing the right inner knob in and turning it, you can leaf through the remainder of the pages for La Guardia.



Figure 3-82

NOTE: This same method may be used with the name of the city where the airport is located.

There are a few changes made to names in order to accommodate the KLX 135A display and to make the names easier to find.

- Names which are too long to fit on the display are abbreviated. The first six characters are usually exactly correct, but the following are exceptions:
 - North, Northern, East, Eastern, etc.—uses N, E
 - Southeast, Northwest, etc.—uses SE, NW
 - Point—uses PT
 - Port—uses PT
 - Fort—uses FT
 - Saint—uses ST
 - General—Deleted, or uses GEN
 - Person's name—uses initials for other than last name unless very well known (Will Rogers World airport)
 - Delete “City of” (City of Colorado Springs Municipal)
 - Delete “Greater” (Greater Buffalo Int'l)
 - Delete “The” (The Hartsfield Atlanta Int'l)
- Unless the first word is greater than eight characters, it is usually not abbreviated.
- Delete most punctuation such as periods and apostrophes.
- Abbreviations for International are INTL, INT, and IN.
- Abbreviations for Regional are REGL and REG.

Basic GPS Operation
Chapter 3

3.8. "NEAREST" FUNCTIONS

At any time, you can have access to the nearest airports, waypoints, Special Use Airspace (SUA), Flight Service Station (FSS) frequencies, and Center frequencies to your position. All you have to do is press the **MSG** button and then the **ENT** button.

When you first do this, a page is displayed asking which nearest function you would like to select (figure 3-83).

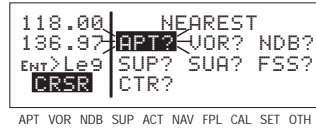

Figure 3-83

The choices are:

- APT** Airports
- VOR** VORs
- NDB** NDBs
- SUP** Supplemental (User-defined) waypoints
- SUA** Special Use Airspaces
- FSS** Flight Service Station Frequencies
- CTR** Center Frequencies

To select the desired nearest function, use the right outer knob to move the cursor to the desired selection and press **ENT**. Notice that the cursor is initially over the **APT** field, so you may press **MSG**, **ENT**, then press **ENT** immediately to access the nearest airports.

Selecting any of the waypoint types (**APT**, **VOR**, **NDB**, or **SUP**) takes you immediately to the waypoint page for the first nearest waypoint of that type, for example, the nearest airport (figure 3-84).

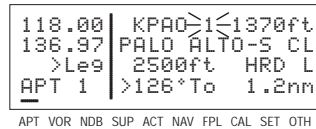

Figure 3-84

3.8.1. VIEWING THE NEAREST WAYPOINTS

There are actually two waypoint scan lists for airports, VORs, NDBs and user-defined waypoints. These two lists are the "complete" list and the "nearest" list. The complete list contains all of the waypoints in the data base for a waypoint type (all the airports, for example). The nearest list consists of the nine nearest waypoints (of that type) to your present position. Therefore, if you are in the nearest airport list, it will contain the nine nearest airports relative to your location.

The nearest list is positioned in front of the complete list. That is, instead of using the **MSG** and **ENT** buttons, you may scan backwards

(turn the right inner knob counterclockwise while in the “pulled-out” position) through the complete list to reach the nearest list. You will know when you have reached the nearest list because the top middle portion of the waypoint page will flash the relative position of the waypoint to your position. “1” indicates nearest (figure 3-84) while “9” indicates the ninth nearest (figure 3-85). As you scan clockwise with the right inner knob “1, 2, 3, ..., 9”, the next scan position is the beginning of the complete list. The nearest list can only be reached by scanning backwards. It does not wrap around after the last waypoint in the complete list.

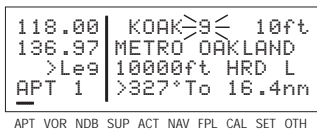

Figure 3-85

Waypoint pages displayed in the nearest list do not contain a latitude and longitude position as they do in the complete list. Instead, the bearing and distance to the waypoint (or the radial and distance from the waypoint) are displayed. In addition, nearest airport pages display the length, surface, and lighting of the longest runway. Once the nearest waypoint is being displayed, the other waypoint pages (for example, APT 2 and APT 3) for that airport are available for display by making sure the right inner knob is pushed in and then turning it to select the desired airport page.

3.8.1.1 Nearest Airport Criteria

The nine airports in the nearest list are the nine airports which meet the criteria selected on the Setup 6 (SET 6) page. For example, you probably wouldn't want to take a turboprop into a 1500 foot grass strip! The SET 6 page allows you to specify what criteria you want an airport to meet before it is considered for the nearest airport list.

To specify the nearest airport criteria:

1. Select the SET 6 page and turn on the cursor (CRSR).

2. Use the right inner knob to select the minimum length runway desired for the airport to qualify for the nearest airport list (figure 3-86). Values between 1000 feet and 5000 feet in 100 foot increments may be selected.

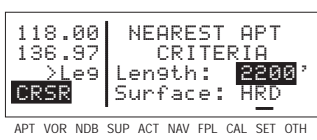

Figure 3-86

3. Rotate the right outer knob clockwise to move the cursor over the runway surface criteria.

- Turn the right inner knob to select either **HRD** or **ANY**. If **ANY** is chosen, then both hard and soft surface runways meeting the required runway length will be included in the nearest airport list. If **HRD** is chosen, then only hard surface runways will be included. Hard surface runways include concrete, asphalt, pavement, tarmac, brick, bitumen, and sealed. Soft surface runways include turf, gravel, clay, sand, dirt, ice, steel matting, shale, and snow.

For example, if the minimum runway criteria selected is **2200** feet in length and **HRD** surface, then only airports having a hard surface runway at least 2200 feet in length will be displayed in the nearest airport list.

3.8.1.2 Continuous Display of Nearest Airport

When the nearest airport page is initially displayed, “1” is displayed in the upper right hand corner of the page to designate this airport as the nearest airport. However, if you continue to fly along your flight plan with this page selected, the same airport will be displayed and its position in the nearest airport list will change from 1 to 2, 3, 4 ... 9 until finally it won't be in the nearest airport list at all. The reason for this is that in the event of an actual emergency once you have determined which airport you are heading for, you don't want the nearest airport list to update while you are maneuvering or looking up data on the other airport pages for that airport.

There may be times, however, when you're flying over “unfriendly” terrain when you wish to always have the nearest airport displayed on the screen.

To display the nearest airport continuously:

- Display the nearest airport page by pressing **MSG**, **ENT**, and **ENT** again.
- Turn on the cursor (**CRSR**).
- Rotate the right outer knob clockwise to position the cursor over “1” (figure 3-87). As long as the cursor is left in this position, this page will update so that the nearest airport is always shown as the flight progresses.

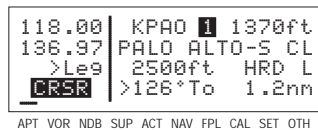

Figure 3-87

3.8.2. VIEWING THE NEAREST SPECIAL USE AIRSPACES

The KLX 135A data base stores the locations of areas of special use airspace (SUA). The types of SUA areas stored in the data base and the abbreviations used to denote these areas are the following:

Class B Airspace	CL B
Class C Airspace	CL C
Control Area (used outside USA)	CTA
Terminal Area (used outside USA)	TMA
Alert Area	ALRT
Danger Area	DNGR
Prohibited Area	PROH
Restricted Area	REST
Terminal Radar Service Area	TRSA

The nearest special use airspace feature is constantly keeping track of the five nearest areas of SUA. Pressing the **MSG** and **ENT** buttons and selecting the **SUA** option will display the SUA 1 page (figure 3-88) for the nearest SUA to your location, including those which you are inside.

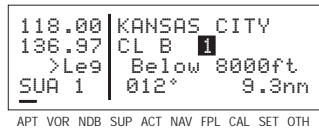

Figure 3-88

Turn to section 3.15 to learn more about how an altitude input affects special use airspace sensing and how the KLX 135A determines if you are inside special use airspace or not.

The SUA 1 page displays the following information:

Line 1: The name of the special use airspace area.

Line 2: The SUA type (see the list of abbreviations above, this particular SUA is Class B airspace), and the sequence number (1st nearest, 2nd nearest, etc.).

Line 3: The altitude limits of the SUA.

Line 4: The proximity of the nearest point on the border of the SUA, in the form of the absolute bearing, relative bearing, and distance to the SUA border. The absolute bearing is the approximate heading you would fly to most quickly get into the SUA. The relative bearing arrow in the middle of this line points to the SUA border, telling you if it is directly ahead of you (), straight off your left wing (), etc. Finally, the distance to the SUA in nautical miles is displayed on the right side of line 4.

If the aircraft is inside the SUA, line 4 will read **A/C INSIDE SUA**, if you are above or below the SUA, as indicated by the encoding altimeter, line 4 will tell you this (**A/C ABOVE SUA** or **A/C BELOW SUA**).

A single clockwise turn of the right inner knob selects the SUA 2 page, which displays either the controlling ATC facility (figure 3-89), or if the special use airspace is a Class B, Class C, CTA, or TMA, the page will be displayed as in figure 3-90, instructing you to press **CLR** to see the APT 4 page (airport communications) for the primary airport so that the correct communications frequency may be determined.

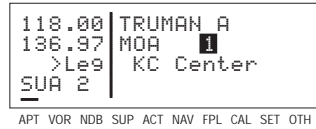

Figure 3-89

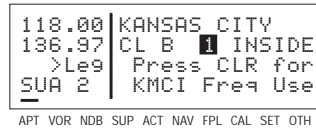

Figure 3-90

To scan through the remainder of the nearest SUA areas, pull the right inner knob to the “out” position and turn it clockwise to view the SUA pages for the second nearest through fifth nearest SUAs.

NOTE: *The KLX 135A displays the five nearest SUAs regardless of your present altitude and the altitude limits of the SUA. For instance, it will include SUAs specified as “Below 6000ft” even if you are cruising at 10,000 feet.*

3.8.3. Viewing the Nearest Flight Service Station Frequencies

The KLX 135A stores in its data base the locations of Flight Service Stations (FSS) and their remote communications sites. In addition, the KLX 135A determines which two of these FSS points of communication are closest to your present location. What a convenience for you! Next time you want to file a flight plan from the air or contact an FSS for some other reason, you can easily use the KLX 135A to determine a suitable FSS and the appropriate frequency.

NOTE: *In some areas of the world the KLX 135A provides the location of the nearest point of communication with a facility providing information (INF) or radio (RDO) services.*

Pressing the **MSG** and **ENT** buttons and selecting the **FSS** option will display two of the nearest points of communication with Flight Service Stations. There will normally be two FSS 1 pages, one for each of the two points of contact. The name of the FSS is at the top of the

page. There can be from one to three frequencies included for a point of contact (figure 3-91). Remember that in the U.S. the frequency 122.00 MHz is used for "Flight Watch" and the frequency 123.60 MHz is used for Aeronautical Advisory Service. As you know, it is often possible to communicate with an FSS by transmitting on 122.10 MHz and listening on the VOR frequency. In cases like this, the FSS 1 page displays the frequencies to use for transmit and receive and also the name of the VOR through which you are communicating (figure 3-92).

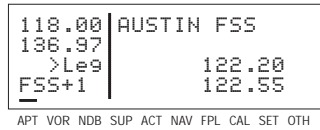

Figure 3-91

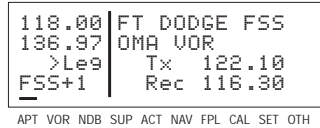

Figure 3-92

NOTE: You may use QuickTune™ to transfer an FSS frequency to the standby frequency in the COMM transceiver by turning on the cursor (*CRSR*), selecting the desired frequency, and pressing *ENT*.

3.8.4. Viewing the Nearest Center Frequencies

The KLX 135A also stores in its data base the low altitude boundaries of each of the ARTCC "Centers". The KLX 135A determines the proper Center to contact and the appropriate frequencies to use for the aircraft's present position. Pressing the *MSG* and *ENT* buttons and selecting the **CTR** option will display this information to you (figure 3-93). Next time you wish to obtain VFR flight following or communicate with Center for any reason, you have a quick way to get a frequency for establishing contact! Appendix D contains a listing of Center abbreviations used on the CTR page.

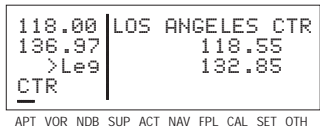



Figure 3-93

NOTE: You may use QuickTune™ to transfer an ARTCC/FIR frequency to the standby frequency in the COMM transceiver by turning on the cursor (*CRSR*), selecting the desired frequency, and pressing *ENT*.

NOTE: Frequencies for Area Control Centers are displayed on the CTR page for some areas of the world.

3.9. DIRECT TO OPERATION

The  button is used to initiate Direct To operation (navigation from your present position direct to your destination). When  is pressed, the Direct To page will be displayed with a flashing cursor over a waypoint identifier (figure 3-94). The waypoint identifier which appears on the Direct To page is chosen by the KLX 135A according to the following rules:

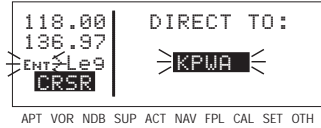





Figure 3-94

1. *If the Flight Plan 0 (FPL 0) page is displayed on the screen and the cursor is over one of the waypoint identifiers in FPL 0 when  is pressed, then that waypoint identifier will appear on the DIR page. You will appreciate this feature when you learn to use flight plans in section 4.2.*
2. *If the KLX 135A is displaying the NAV 5 page and the right inner knob is in the “out” position, then the waypoint highlighted in the lower right hand corner of the NAV 5 map display will be the default waypoint. You will also find this feature useful when operating from the active flight plan.*

OR . . .

3. *If there is any waypoint page (APT, VOR, NDB, SUP, or ACT page) in view when  is pressed, then the DIR page will contain the identifier for the waypoint just viewed.*

If none of the conditions above is occurring, then:

4. *When  is pressed, the waypoint identifier for the current active waypoint will be displayed on the DIR page.*

If there is no active waypoint when  is pressed, then:

5. *The Direct To page displays blanks in the waypoint identifier field. In order for there not to be an active waypoint, there is no Direct To waypoint and there are no waypoints in Flight Plan 0.*

3.9.1. INITIATING A DIRECT TO

Now that you know the ground rules, let's go ahead and try some practical examples. First, let's say we wanted to fly directly to Wexford County Airport in Cadillac, Michigan. Its ICAO identifier is KCAD.

To fly Direct To a waypoint (procedure 1):

1. Press **[ENT]**. The Direct To page is displayed (figure 3-95). The cursor will already be on. A waypoint identifier may or may not be displayed, it doesn't matter at this point.
2. Rotate the right inner knob to select the first character of the desired waypoint's identifier, in this case, a "K" (figure 3-96). Remember to enter the "K", "C", or "P" prefix for certain airports in North America, if required (see section 2.3, "ICAO Identifiers").
3. Turn the right outer knob one click clockwise to move the flashing portion of the cursor over the second character position (figure 3-97).
4. Rotate the right inner knob to select the second character of the identifier (figure 3-98).
5. Use right outer and inner knobs as in the previous steps until the desired identifier is completely displayed (figure 3-99).
6. Press **[ENT]** to display the waypoint page for the selected waypoint (figure 3-100).
7. Press **[ENT]** again to approve the displayed waypoint page. The screen will change to the NAV 1 page, and the selected waypoint will now be the active Direct To waypoint (figure 3-101).

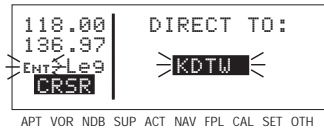

Figure 3-95

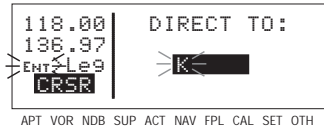

Figure 3-96

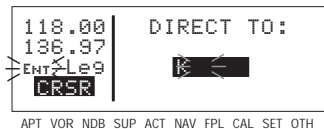

Figure 3-97

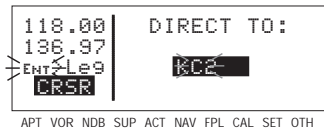

Figure 3-98



Figure 3-99

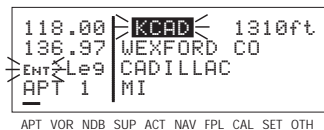

Figure 3-100

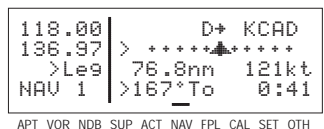

Figure 3-101

Basic GPS Operation
Chapter 3

To fly Direct To a waypoint (procedure 2):

1. Select the desired waypoint page (APT, VOR, NDB, or SUP) on the screen (figure 3-102) using one of the three procedures explained in section 3.9.

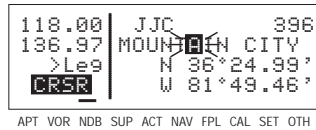

Figure 3-102

2. Press **[▶]**. The Direct To page is displayed and it contains the desired waypoint identifier (figure 3-103).

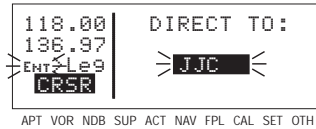

Figure 3-103

3. Press **[ENT]**. The display will revert to the NAV 1 page with the selected waypoint as the Direct To waypoint.

If you get off course and wish to recenter the left/right deviation bar (D-Bar) to proceed to the same waypoint, use the following procedure:

To recenter the D-Bar by going direct to the active waypoint:

1. Select a non-waypoint page (**NAV**, **FPL**, **CAL**, **SET**, or **OTH**) on the screen.
2. Press **[▶]**. The Direct To page is displayed on the left, containing the active waypoint identifier.
3. Press **[ENT]**.

3.9.2. CANCELING A DIRECT TO

To cancel Direct To operation:

The primary reason for wanting to cancel Direct To operation is to return to flight plan operation which is described later in section 4.2.4 “Combining Direct To and Flight Plan Operation”.

1. Press **[▶]**.
2. Press **[CLR]** to blank out the waypoint identifier field (figure 3-104).
3. Press **[ENT]**.



Figure 3-104

3.9.3. WAYPOINT ALERTING FOR DIRECT TO OPERATION

Approximately 36 seconds prior to reaching a Direct To waypoint, the arrow preceding the waypoint identifier on the waypoint page for the active waypoint will begin flashing. This arrow will also be flashing on any NAV or FPL page displaying the active waypoint identifier. This is called "waypoint alerting". If an external waypoint alert annunciator is mounted in the aircraft, this annunciator will begin flashing at the same time.

3.10. NAVIGATION PAGES

As you would expect, the NAV (navigation) pages contain information relating specifically to the KLX 135A's navigation capabilities. The KLX 135A has five NAV pages. The procedure for selecting specific pages, including the NAV pages, was described in section 3.4.1, "Page Selection".

3.10.1. THE NAVIGATION 1 (NAV 1) PAGE

The NAV 1 page is the primary navigation display, and is shown in figure 3-105. In normal flight, you will probably want to view this page quite often. A NAV 1 page displays the following information:

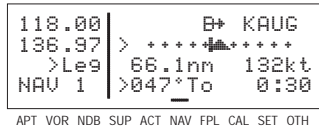

Figure 3-105

Line 1: The active navigation leg. For Direct To operation this consists of the Direct To symbol, B+, followed by the active Direct To waypoint identifier (figure 3-105). For the leg of a flight plan this consists of the "from" waypoint identifier and the active "to" waypoint identifier (figure 3-106). An arrow + precedes the active waypoint identifier.

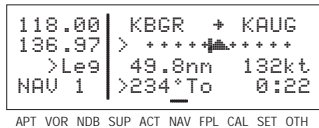

Figure 3-106

Line 2: A cyclic field which can either be (1) a course deviation indicator (CDI) that graphically displays left and right deviation from desired track (figure 3-106), or (2) The direction to fly to intercept the desired track and the crosstrack distance (figure 3-107). In either case, the same information is displayed. This is a cyclic field, so you can change back and forth from

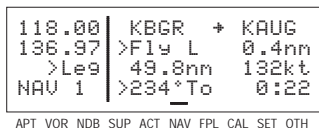

Figure 3-107

the two options by turning on the cursor (**CRSR**) over the second line and pressing the **CLR** button.

The CDI's vertical bar operates like a navigation deviation needle on a conventional CDI or HSI using VOR/Localizer navigation. An on-course indication is displayed when the vertical deviation bar is centered on the triangle in the middle of the CDI. In both modes (Leg and OBS, see section 4.5), each dot represents one nautical mile deviation from the desired track. Therefore, the CDI shows course deviation five nautical miles left and right of course. A vertical deviation bar positioned two dots to the right of the center triangle indicates the aircraft is two nautical miles to the left of course (figure 3-108).

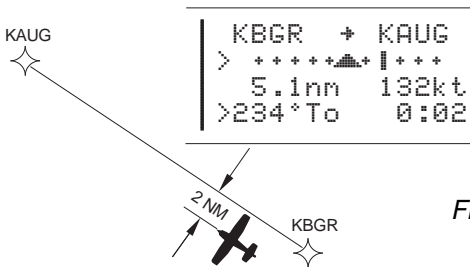
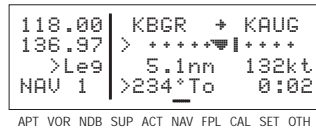

Figure 3-108

The center triangle also serves as the CDI's TO/FROM indicator and operates in the same manner as a conventional CDI TO/FROM indicator; a triangle pointing up indicates "to" the active waypoint while a "down" triangle (figure 3-109) indicates "from" the active waypoint. The word **FLAG** is displayed over the CDI when the KLX 135A is not usable for navigation (figure 3-110).



APT VOR NDB SUP ACT NAV FPL CAL SET OTH

Figure 3-109

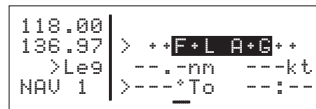

APT VOR NDB SUP ACT NAV FPL CAL SET OTH

Figure 3-110

The numerical crosstrack distance display is especially handy when more than five nautical miles off of course (naturally, you yourself would never deviate more than five nm off course, but not everyone is as good a pilot as you are!) If your crosstrack distance was 13.1 nautical miles left of course, the graphic CDI needle will be pegged on the right side (which doesn't tell you much). But this presentation will show you exactly how far off course you are (figure 3-111). When the

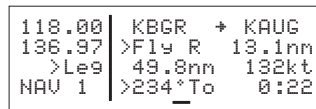

APT VOR NDB SUP ACT NAV FPL CAL SET OTH

Figure 3-111

KLX 135A is not usable for navigation, the crosstrack distance will be dashed out (figure 3-112).

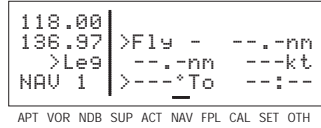

Figure 3-112

Line 3: Distance from present position to the active waypoint and the calculated groundspeed.

Line 4: A cyclic field which can display either bearing to the active waypoint (**To**) or radial from the active waypoint (**Fr**) relative to the present position. By placing the cursor over this field and pressing the **CLR** button, you may toggle between the two options.

NOTE: Due to “great circle” courses and magnetic variation differences between present position and the active waypoint, the To bearing and From radial may not be exactly 180° different from each other when the system is in the Leg mode. This condition is most likely to occur when long distances are involved, and/or you are operating in very northerly or southerly latitudes. See figure 3-113 for an example depicting a case like this. The aircraft is somewhere over Georgia, and the active waypoint is KPHX. The bearing to steer is 269°, and radial is 72°. Generally, you will want to use bearing (not radial) when long distances are involved.

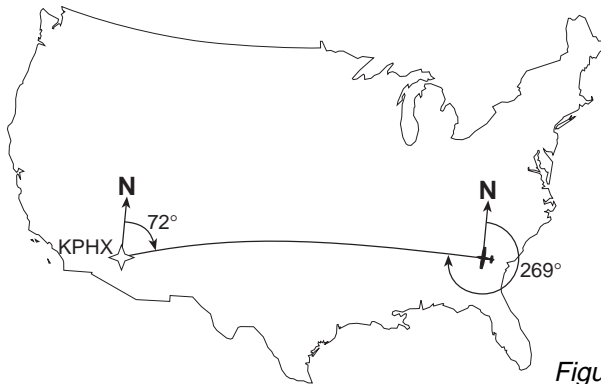

Figure 3-113

Line 4 also displays the estimated time en route (ETE) from present position to active waypoint.

3.10.2. THE NAVIGATION 2 (NAV 2) PAGE

The NAV 2 pages in figures 3-114 and 3-115 display the aircraft's present position in one of two formats. The first line is a cyclic field which allows you to toggle between formats. When the NAV 2 page is first displayed, it defaults to present position in terms of the radial and distance from a nearby VOR. You can change the reference waypoint from the nearby VOR to any waypoint.

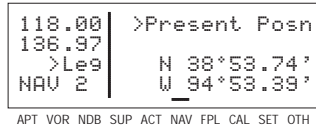

Figure 3-114

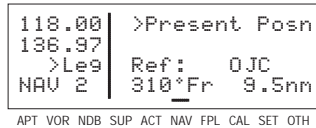

Figure 3-115

To change the NAV 2 page present position reference waypoint:

1. With the NAV 2 page on the radial and distance from a reference waypoint format, turn on the cursor (CRSR) and move it to the Ref: field (figure 3-116).
2. Use the right inner and outer knobs to enter the waypoint you wish to use as a reference.
3. Press ENT. The waypoint page for the identifier just entered will be displayed.
4. If this is the waypoint you intend, press ENT again. The display will return to the NAV 2 page (figure 3-117).

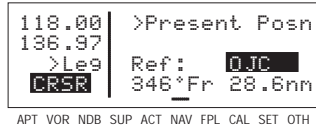

Figure 3-116

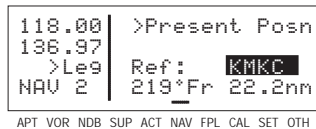

Figure 3-117

NOTE: If you change the reference waypoint, change to a page other than the NAV 2 page, then turn back to the NAV 2 page, the reference waypoint will revert back to a nearby VOR.

By turning on the cursor (CRSR) over the first line and pressing CLR, you can change to the latitude and longitude format.

3.10.3. THE NAVIGATION 3 (NAV 3) PAGE

The Navigation (NAV) 3 page shows you several important times pertaining to your flight (figure 3-118).

118.00	Time	CDT	1605
136.97	Depart		1343
>Leg	ETA	KIXD	1710
NAV 3	Flight		2:22

APT VOR NDB SUP ACT NAV FPL CAL SET OTH

Figure 3-118

Line 1: The current system time zone and time. The time zone may be changed by turning the cursor (**CRSR**) on over it and turning the right inner knob. All times shown on the NAV 3 page are in terms of the system time zone (except for the flight time, which is an elapsed time).

Line 2: The time of departure. This is the time when a valid ground-speed was first greater than 30 knots (typically during takeoff).

Line 3: Estimated time of arrival at your destination. If the active waypoint is not part of the active flight plan, the active waypoint will be the destination. Otherwise, the last waypoint in your active flight plan will be the destination.

Line 4: The elapsed flight time, which will be the hours and minutes since the departure time.

3.10.4. THE NAVIGATION 4 (NAV 4) PAGE

The Navigation (NAV) 4 page (figure 3-119) shows some supplemental navigation data.

118.00	KICT	+	KMCI
136.97	Dtk		051°
>Leg	Track		046°
NAV 4	Brq		050°

APT VOR NDB SUP ACT NAV FPL CAL SET OTH

Figure 3-119

Line 1: The active waypoint or leg, just like the NAV 1 page.

Line 2: The present desired track (**Dtk**). This is the great circle course between two waypoints. Any CDI or HSI driven by the KLX 135A, including the CDI displayed on the NAV 1 page, is referenced to this desired track. You may wish to look at the navigation terminology diagram in Appendix A at this time if you are unfamiliar with terms like desired track and actual track.

NOTE: If the KLX 135A is in the OBS mode, the selected course (**Obs**) is displayed instead of the desired track on the NAV 4 page.

Line 3: Actual track (**Track**) -- the aircraft's present track over the ground. If you are trying to establish a heading on a new leg of your flight, it is very helpful to look at the difference between the actual track and the desired track and adjust your heading accordingly to allow for crosswind.

Line 4: Bearing (**Brg**) -- the magnetic bearing from present position to the active waypoint.

3.10.5. THE NAVIGATION 5 (NAV 5) PAGE

The NAV 5 page is a graphical moving map which offers excellent "bird's-eye-view" situational awareness to you as the pilot in command. This page can show you where you are and where you're headed relative to your active flight plan or leg, your destination waypoint(s), the nearby airports and VORs, and even the boundaries of nearby special use airspace!

The NAV 5 page (figure 3-120) is a little bit different than some of the other KLX 135A pages. Instead of displaying the page type and number (i.e. NAV 5) in the lower left corner of the screen, an additional piece of navigation data is displayed here. We're willing to bet you'll know this is the NAV 5 page anyway, because of its unique graphics.

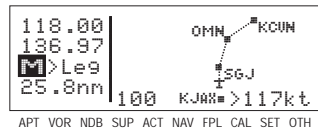

Figure 3-120

The left side of the screen displays the COMM frequencies and mode annunciation (either **Leg**, or the OBS selected course), just like it usually would, but the fourth line displays distance to go to the active waypoint. In the lower right corner of the NAV 5 map display is a cyclic field for which you may select:

Magnetic Desired Track (degrees)	DTK123
Groundspeed (knots)	123kt
Estimated Time Enroute (hours:minutes)	1:23
Crosstrack Correction (nautical miles)	1.23→
Blank (for a less cluttered map display)	Map

NOTE: The "Map" selection clears this area of the screen when the cursor is removed from the screen so it may be utilized by the map.

NOTE: Magnetic desired track may only be selected when KLX 135A is in the Leg navigation mode. When the KLX 135A is in the OBS mode, the "desired track" is the same as the OBS selected course displayed on line 3.

To change the data displayed in this cyclic field, simply turn on the cursor (CRSR), rotate the right outer knob clockwise to position the cursor over this field (figure 3-121), and press the CLR button to choose the desired information.

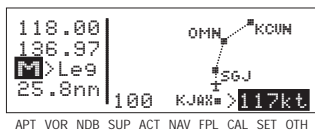

Figure 3-121

Now we move on to the map display area on the right side of the screen. In all KLX 135A installations there are three common map orientation formats that may be selected on the NAV 5 page: a True North up display, a desired track up display, or an actual track up display. When the North up display is selected, viewing the NAV 5 page is like looking at a navigation chart with North at the top. When the desired track up display is selected the NAV 5 page is like looking at a chart that is turned so that your course line is always pointing up. When the actual track up display is selected, viewing the NAV 5 page is like looking at a chart that is turned so that the direction the aircraft is tracking over the ground is pointing up. In a no-wind condition, actual track is identical to the aircraft's heading.

CAUTION: When using the actual track up format it is typical for there to be a slight delay from the time a heading change is made until the correct map orientation is displayed. Be careful when using either the desired track up display or the actual track up display to not think that a heading up display is being used.

When you are navigating with a flight plan (see section 4.2), the NAV 5 page displays the waypoints of the active flight plan (FPL 0) with their waypoint identifiers (figure 3-121). Course lines connect the flight plan waypoints.

When operating Direct To a waypoint which is not in the active flight plan, the direct to waypoint is shown on the map, and although the waypoints of the active flight plan are still shown on the screen, they are not connected by course lines (figure 3-122).

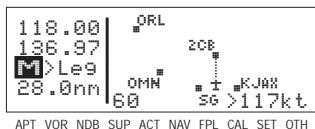

Figure 3-122

In the lower left corner of the map display area is the map range scale in nautical miles. The range scale indicates the distance from the aircraft's position to the top of the screen. You may select a range scale of 1 NM to 500 NM with several choices in between by turning on the cursor (**CRSR**), and using the right inner knob to select the desired range scale. For example, figure 3-123 illustrates the results of changing the range scale of the map in figure 3-122 from 60 nautical miles to 30 nautical miles.

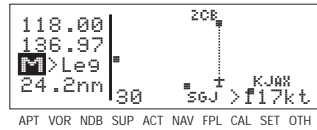

Figure 3-123

Additionally, there is a choice called **AUTO**, for automatic range scaling. This choice is sandwiched between the 1 NM scale and the 500 NM scale, such that it is “below” 1 NM and “above” 500 NM. The AUTO scale factor feature “zooms” the map in and out in a useful way so that you don’t have to. Specifically, AUTO chooses the smallest map scale that will display the active waypoint and, if there is one, the waypoint after the active waypoint. Choosing the AUTO scale factor means there is one less item for you to worry about.

Aside from changing the map range scale, all other customization of the map display is done from the menu. Notice that when you turn on the cursor (**CRSR**), the **Menu?** field appears above the range scale. Turn the right outer knob one step counter-clockwise to move the cursor over the **Menu?** field (figure 3-124) and press **ENT**. The menu now “pops-up” on the screen (figure 3-125).

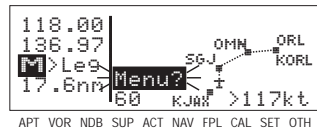

Figure 3-124

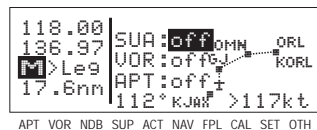

Figure 3-125

To select the desired NAV 5 orientation, you must first select the menu, then use the right outer knob to position the cursor over the map orientation field (figure 3-126). Rotate the right inner knob to display **N** for North up, **DTK** for desired track up (figure 3-127) or **TK** for actual track up. If the cursor is located on a field other than the map orientation field, then the **DTK** or **TK** annunciation is

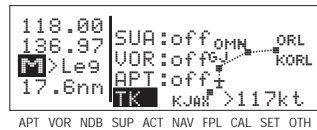

Figure 3-126

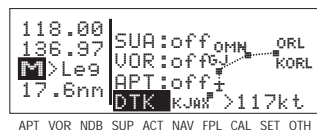

Figure 3-127

replaced with the actual value. The **123°** displayed in figure 3-128 shows how the actual track is displayed when the cursor is not over the map orientation field.

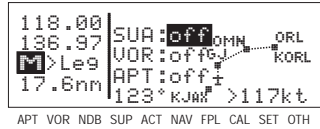

Figure 3-128

Actual track up display is usually preferred for use in flight. However, the track up display is only usable when the aircraft is moving 2 knots or more so the North up display may be a good choice if you are stationary.

Notice that in both the North up format and the desired track up format, the aircraft's position is depicted by a diamond. In the actual track up format, the aircraft's position is depicted by an aircraft symbol.

You may choose to have nearby airports, VORs, and special use airspace (SUA) displayed on the moving map! To do so, use the pop-up menu by turning on the cursor and selecting **Menu?**

When the menu is first displayed the cursor will be on the SUA selection field. Rotate the right inner knob to select **on** or **off**. When SUAs are selected, the five nearest SUAs are displayed. However, they will not be displayed on map range scales larger than 160 NM. Special use airspace areas are displayed regardless of your altitude relative to the airspace. The nearest SUA feature (section 3.8.2) and the SUA alerting feature (section 3.15) will indicate the altitude limits of the airspace to you. Section 3.15 will also help you understand more about the KLX 135A special use airspace features as well as the types of SUA that are included in the KLX 135A data base.

NOTE: Only the outer lateral boundaries are displayed for Class B, Class C, CTA, and TMA airspace. The actual SUA may have different lateral limits (i.e. smaller) depending on your present altitude.

In the same manner, the nearest VORs and/or airports may be selected by first using the right outer knob to move the cursor over the VOR or APT selection field and then using the right inner knob to select **on** or **off**. The example in figure 3-129 shows SUAs and airports having been selected.

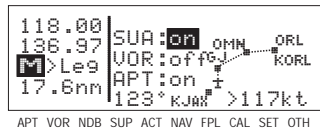

Figure 3-129

When the desired selections have been made, press the **CRSR** button to remove the menu from the screen (figure 3-130). Notice that the nearest airports are depicted with a small **+** symbol, while the VORs are shown as a small box (■).

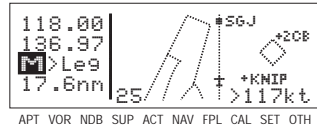

Figure 3-130

One last item of interest on this page: you may change the active waypoint to any of the flight plan waypoints without having to leave the map display. This is done by pulling the right inner knob to the “out” or “scan” position. This will cause the identifier for the active waypoint to be displayed in the bottom right corner of the screen (figure 3-131). The waypoint displayed in this area will be the default waypoint when **→** is pressed. By turning the right inner knob it is possible to scan through the waypoints of the active flight plan (FPL 0). Turning the knob clockwise will scan through the waypoints in sequence until the end of the flight plan is reached. Turning the knob counter-clockwise will scan through the active flight plan in reverse order until the beginning of the flight plan is reached. Pushing the right inner knob back to the “in” position will remove this text from the map display area.

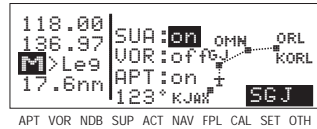

Figure 3-131

The following hints will make using the NAV 5 page more enjoyable.

- It is easy to clutter the display with so much data that it is unusable. Select a range scale that allows an uncluttered presentation of the chosen SUAs, VORs, and airports. Or, select another combination of these from the menu. Experiment and continue to make new selections for different phases of your trip.
- Press **CLR** to instantly declutter the SUA, VOR, and airport selections from the graphics display. Flight plan and Direct To waypoints will still be displayed. Press **CLR** again to restore the selections.

CAUTION: The NAV 5 page does not display weather, terrain, or other data.

3.11. WAYPOINT PAGES

NOTE: Each of the waypoint page types includes a cyclic field which displays present magnetic bearing to or magnetic radial from the waypoint. Due to "great circle" courses and magnetic variation differences between present position and the active waypoint, the To bearing and From radial may not be exactly 180° different from each other. This condition is most likely to occur when long distances are involved, and/or you are operating in very northerly or southerly latitudes. See section 3.10.1 and figure 3-113 for more details.

3.11.1. AIRPORT PAGES

3.11.1.1. The Airport 1 (APT 1) Page

See figure 3-132.

Line 1: The ICAO identifier (see section 2.3) of the airport; an arrow precedes the identifier if it is the active waypoint. The airport elevation above MSL in feet, which is rounded to the nearest 10 feet.

Line 2: The name of the airport.

Line 3: The city where the airport is located.

Line 4: The State if the airport is located in the U.S., the Province if located in Canada, or the country if outside the U.S. and Canada. A listing of the abbreviations used for States, Provinces, and countries is contained in Appendix D. The right side of line 4 will read **MILITARY** if it is a military airport (Figure 3-133) or **PRIVATE** if it is a private-use airport.

If the airport is being viewed as part of the *nearest airports list* (see section 3.8.1, "Viewing the Nearest Waypoints"), the APT 1 page format will differ as follows (see figure 3-134):

Line 1: After the airport identifier, the number designating the airport's position in the nearest airport list is displayed. In figure 3-134, KLIT is the third nearest airport.

118.00	KLIT	260ft
136.97	ADAMS	
>Le9	LITTLE ROCK	
APT 1	AR	

APT VOR NDB SUP ACT NAV FPL CAL SET OTH

Figure 3-132

118.00	KSZL	870ft
136.97	WHITEMAN AFB	
>Le9	KNOB NOSTER	
APT 1	MO	MILITARY

APT VOR NDB SUP ACT NAV FPL CAL SET OTH

Figure 3-133

118.00	KLIT	>3<	260ft
136.97	ADAMS		
>Le9		7200ft	HRD L
APT 1		>103°To	14.5nm

APT VOR NDB SUP ACT NAV FPL CAL SET OTH

Figure 3-134

Line 2: Same as a normal APT 1 page.

Line 3: The length, surface, and lighting of the longest runway.

Line 4: The magnetic bearing to or the magnetic radial from the airport and the distance in nautical miles. Placing the cursor over the radial/bearing field and pressing toggles between radial from and bearing to the airport.

3.11.1.2. The Airport 2 (APT 2) Page

See figure 3-135.

Line 1: The ICAO identifier (see section 2.3) of the airport; an arrow precedes the identifier if it is the active waypoint.

118.00	KLIT
136.97	N 34°43.74'
>Le9	W 92°13.47'
APT 2	>103°To 14.5nm
<small>APT VOR NDB SUP ACT NAV FPL CAL SET OTH</small>	

Figure 3-135

Lines 2-3: The latitude and longitude of the airport reference point (the “official” location of the airport).

Line 4: The magnetic bearing to or the magnetic radial from the airport and the distance in nautical miles. Placing the cursor over the radial/bearing field and pressing toggles between radial from and bearing to the airport.

If the airport is being viewed as part of the *nearest airports list* (see section 3.8.1, “Viewing the Nearest Waypoints”), the APT 2 page format will differ as follows (see figure 3-136):

118.00	KLIT>3<
136.97	LITTLE ROCK
>Le9	AR
APT 2	>103°To 14.5nm
<small>APT VOR NDB SUP ACT NAV FPL CAL SET OTH</small>	

Figure 3-136

Line 1: After the airport identifier, the number designating the airport’s position in the nearest airport list is displayed.

Line 2: The city where the airport is located.

Line 3: The State if the airport is located in the US., the Province if located in Canada, or the country if outside the US. and Canada. A listing of the abbreviations used for States, Provinces, and countries is contained in Appendix D. The right side of line 4 displays **MILITARY** if it is a military airport or **PRIVATE** if it is a private-use airport.

Line 4: The magnetic bearing to or the magnetic radial from the airport and the distance in nautical miles. Placing the cursor over the radial/bearing field and pressing toggles between radial from and bearing to the airport.

3.11.1.3. The Airport 3 (APT 3) Page

See figure 3-137.

118.00	KLIT	04R/22L
136.97	7200'	HRD L
>Le9		04L/22R
<u>APT+3</u>	7173'	HRD L
<small>APT VOR NDB SUP ACT NAV FPL CAL SET OTH</small>		

Figure 3-137

The APT 3 page displays the runway designation, length, surface, and lighting for up to five runways in order of length, beginning with the longest runway. Since there are many times when all of an airport's runway information does not fit on one page, additional APT 3 pages are used to display the data. Remember that a "+" inserted between the page type and the number (**APT+3** in this case) is used to indicate that there is more than one Airport 3 page.

Line 1: The ICAO identifier (see section 2.3) of the airport; an arrow precedes the identifier if it is the active waypoint. To the right is the runway designation for the first runway on the page.

NOTE: In some parts of the world, runway numbers are based on true runway heading rather than magnetic. These runways are prevalent in northern Canada, where there is a large magnetic variation gradient. For these runways, a ∇ symbol separates the two runway numbers (example 14 ∇ 32).

Line 2: The runway length for the first runway listed on the page, the runway surface type and the type of lighting (blank if none).

Runway surface abbreviations:

- HRD** Hard surface
- TRF** Turf
- GRV** Gravel
- CLY** Clay
- SND** Sand
- DRT** Dirt
- SNW** Snow
- ICE** Ice
- SHL** Shale
- MAT** Steel mat

Runway lighting Abbreviations:

- L** Sunset to sunrise
- LPC** Pilot controlled lighting
- LPT** Part-time or on-request lighting

Lines 3-4: Runway information for the next shortest runway (if any), in the same format as lines 1 and 2.

In the event that there is no runway information for an airport, the following message is displayed on the APT 3 page:

No Runway Data

3.11.1.4. THE AIRPORT 4 (APT 4) PAGE

See figure 3-138.

Line 1: The ICAO identifier (see section 2.3) of the airport; an arrow precedes the identifier if it is the active waypoint.

118.00	KLIT	
136.97	ATIS	125.60
>Le9	PTX	118.95
APT+4	TWR *	121.90
<small>APT VOR NDB SUP ACT NAV FPL CAL SET OTH</small>		

Figure 3-138

Lines 2-4: The VHF communication frequencies associated with the airport. The type and frequency is listed. The abbreviations are:

AAS	aeronautical advisory service
AFIS	aerodrome flight information service
ARVL	arrival
APR	approach
ATF	aerodrome traffic frequency
AWOS	automatic weather observing station
ATIS	automatic terminal information service
CL B	class B airspace (formerly terminal control area)(VFR frequency)
CL C	class C airspace (formerly airport radar service area) (VFR frequency)
CLR	clearance delivery
CTA	control area (VFR frequency used outside the U.S.)
CTAF	common traffic advisory frequency
CTR	center (when center is used for approach/departure control)
DEP	departure
DIR	director (approach control/radar)
GRND	ground control
MCOM	multicom
MF	mandatory frequency
PCL	pilot-controlled lighting
PTAX	pre-taxi clearance
RAMP	ramp/taxi control
RDR	radar-only frequency
TMA	terminal area (VFR frequency used outside the U.S.)
TWR	control tower
UNIC	unicom

Part-time operation, such as for a control tower, is indicated with an asterisk (*) to the right of an airport frequency.

The frequencies associated with Class B or C airspace, CTA or TMA are VFR frequencies. Airports which have one of these categories of frequencies also have APR and DEP which are IFR frequencies.

Where required, APR, DEP, CL B, CL C, CTA, and TMA frequencies are sectorized. That is, a frequency may be used only within a certain range of radials from a designated reference location. The format for displaying the sectorization is to show the frequency first, followed by the identifier of the associated reference point, followed next by the associated altitude restrictions. For example, figure 3-139 shows that the Orlando approach control frequency 121.10 MHz is used between the 311° radial and the 60° radial from KMCO (Orlando International Airport) for altitudes at and below 5500 feet.

```

118.00 | KORL
136.97 | APR      121.10
>Leg  | KMCO 311°-060°
APT+4 | Below 5500'
    
```

APT VOR NDB SUP ACT NAV FPL CAL SET OTH

Figure 3-139

In a few cases, APR, DEP, CL B, CL C, CTA, and TMA frequencies are sectorized such that the restrictions cannot be displayed on a single page. When this occurs the following message is displayed on the APT 4 page:

**Text of Freq Use
Not Displayed**

3.11.1.5. The Airport 5 (APT 5) Page

See figure 3-140.

Line 1: The ICAO identifier (see section 2.3) of the airport; an arrow precedes the identifier if it is the active waypoint.

```

118.00 | KLIT
136.97 | [Remarks]
>Leg  |
APT 5 |
    
```

APT VOR NDB SUP ACT NAV FPL CAL SET OTH

Figure 3-140

Lines 2-4: The pilot-entered remarks for the airport. Three lines of 14 characters each are available for the remarks. These remarks might include information on lodging, dining, airport services, etc. Up to 100 waypoints may include remarks. Letters, numbers, hyphens, and spaces may be used in the remark. If no remarks have been entered for the airport, line 2 will display “[Remarks]”.

To enter an airport remark on the APT 5 page:

1. Turn on the cursor and move it until the cursor fills line 2 of the screen (figure 3-141).

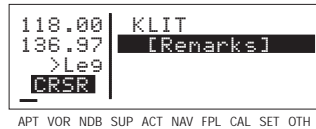

Figure 3-141

2. With the right inner knob, select the desired character, if any, and move the cursor to the next character on the line (figure 3-142).

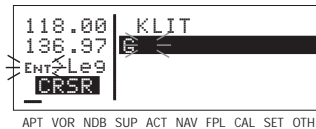

Figure 3-142

3. Repeat step 2 as necessary.

4. Press **ENT** to approve each line of remarks. The cursor will automatically move to the next line (see figure 3-143).

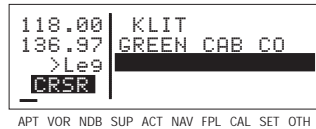

Figure 3-143

5. Turn the cursor off when you are finished creating the remark (figure 3-144).

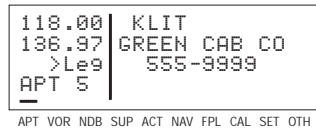

Figure 3-144

The Other 4 (OTH 4) page is a list of waypoints with associated remarks. Sometimes these are deleted if there are more than 100 waypoints with remarks, or if the remarks are no longer relevant. If you wish to delete a waypoint remark for an airport, see section 3.13.2.2.

3.11.2. VOR PAGES

Two pages of information may be displayed for each VOR in the KLX 135A. Sample VOR pages are shown in figures 3-145 through 3-147.

3.11.2.1. The VOR 1 Page

See figure 3-145.

Line 1: The VOR identifier, preceded by an arrow if it is the active waypoint. To the right of the identifier is the frequency of the VOR in megahertz.

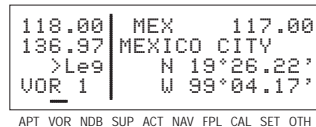

Figure 3-145

Line 2: The name of the VOR.

Lines 3-4: The latitude and longitude of the VOR.

If the VOR is being viewed as part of the *nearest VORs list* (see section 3.8.1), the VOR 1 page format will differ as follows (see figure 3-146):



Figure 3-146

Line 1: After the VOR identifier, the number designating the VOR's position in the nearest VOR list is displayed. In figure 3-146, **MEX** is the second nearest VOR.

Lines 3-4: In place of the latitude/longitude, line 3 is blank and line 4 displays the magnetic bearing to or the magnetic radial from the VOR and the distance in nautical miles. Placing the cursor over the radial/bearing field and pressing **[CLR]** toggles between radial from and bearing to station.

3.11.2.2. The VOR 2 Page

See figure 3-147.

Line 1: The VOR identifier, preceded by an arrow if it is the active waypoint.

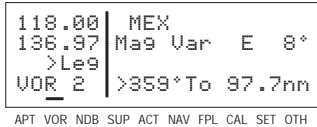

Figure 3-147

Line 2: The published magnetic station declination of the VOR. Magnetic station declination is another way to say the published magnetic variation for the VOR.

Line 4: The magnetic bearing to or the magnetic radial from the VOR and the distance in nautical miles. Placing the cursor over the radial/bearing field and pressing **[CLR]** toggles between radial from and bearing to station.

3.11.3. NDB PAGES

Two pages of information may be displayed for each NDB in the KLX 135A. Sample NDB pages are shown in figures 3-148 through 3-150.

3.11.3.1. The NDB 1 Page

See figure 3-148.

Line 1: The NDB identifier, preceded by an arrow if it is the active waypoint. To the right of the identifier is the frequency of the NDB in kilohertz.

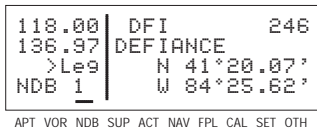

Figure 3-148

Line 2: The name of the NDB.

Lines 3-4: The latitude and longitude of the NDB

If the NDB is being viewed as part of the *nearest NDBs list* (see section 3.8.1), the NDB 1 page format will differ as follows (see figure 3-149):

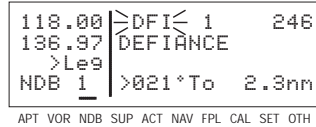

Figure 3-149

Line 1: After the NDB identifier, the number designating the NDB's position in the nearest NDB list is displayed. In figure 3-149, DFI is the nearest NDB.

Lines 3-4: In place of the latitude/longitude, line 3 is blank and line 4 displays the magnetic bearing to or the magnetic radial from the NDB and the distance in nautical miles. Placing the cursor over the radial/bearing field and pressing toggles between radial from and bearing to station.

3.11.3.2. The NDB 2 Page

See figure 3-150.

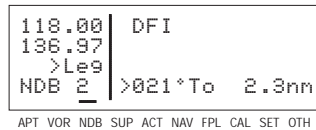

Figure 3-150

Line 1: The NDB identifier, preceded by an arrow if it is the active waypoint.

Line 4: The magnetic bearing to or the magnetic radial from the NDB and the distance in nautical miles. Placing the cursor over the radial/bearing field and pressing toggles between radial from and bearing to station.

3.11.4. SUPPLEMENTAL WAYPOINT PAGES

The Supplemental waypoint pages (SUP 0, SUP 1, SUP 2, and SUP 3) allow you to create "custom" waypoints for use in navigation. A crop sprayer might want to create a waypoint on a field that is sprayed regularly, for instance. Another candidate might be a small airport which is not included in the KLX 135A data base. To learn how to create a user-defined waypoint, see section 4.4.

3.11.4.1. The Supplemental 0 (SUP 0) Page

See figure 3-151.

NOTE: The SUP 0 page is only displayed for waypoint identifiers that do not have a previously defined position.

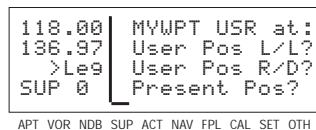

Figure 3-151

Line 1: The identifier for the as-yet-undefined waypoint.

Lines 2-4: Cursor fields for the three possible user-defined waypoint creation methods. For information on creating user-defined waypoints, see section 4.4.

3.11.4.2. The Supplemental 1 (SUP 1) Page

See figure 3-152.

Line 1: The user-defined waypoint identifier, preceded by an arrow if it is the active waypoint. To the right of the identifier are the letters "USR" to signify that this is a user-defined waypoint.

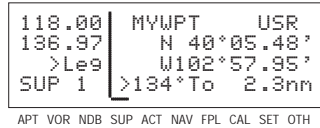

Figure 3-152

Lines 2-3: The latitude and longitude of the user-defined waypoint.

Line 4: The magnetic bearing to or the magnetic radial from the user-defined waypoint and the distance in nautical miles. Placing the cursor over the radial/bearing field and pressing **[CLR]** toggles between radial from and bearing to station.

3.11.4.3. The Supplemental 2 (SUP 2) Page

See figure 3-153.

Line 1: The user-defined waypoint identifier, preceded by an arrow if it is the active waypoint. To the right of the identifier are the letters "USR" to signify that this is a user-defined waypoint.

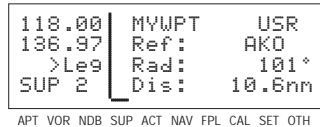

Figure 3-153

Line 2: The identifier of the user-defined waypoint's reference waypoint. When this page is first viewed, the reference waypoint is the nearest VOR to the user waypoint. The reference waypoint may be changed by the pilot. However, once you leave this page and come back, the reference waypoint reverts back to a nearby VOR.

Line 3: The magnetic radial from the reference waypoint to the user waypoint.

Line 4: The distance in nautical miles from the reference waypoint to the user waypoint.

3.11.4.4. The Supplemental 3 (SUP 3) Page

See figure 3-154.

Line 1: The identifier of the user-defined waypoint; an arrow precedes the identifier if it is the active waypoint.

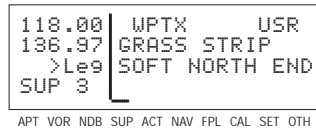

Figure 3-154

Lines 2-4: The pilot-entered remarks for the user waypoint. Three lines of 14 characters each are available for the remarks. Up to 100 waypoints may include remarks. Letters, numbers, hyphens, and spaces may be used in the remark. If no remarks have been entered for the user-defined waypoint, line 2 will display **[Remarks]**.

To enter a user-defined waypoint remark on the SUP 3 page:

1. Turn on the cursor and move it until the cursor fills line 2 of the screen (figure 3-155).

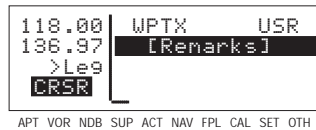

Figure 3-155

2. Select the desired character, if any, and move the cursor to the next character on the line (figure 3-156).

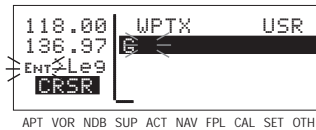

Figure 3-156

3. Repeat step 2 as necessary.
4. Press **ENT** to approve each line of remarks. The cursor will automatically move to the next line (see figure 3-157).
5. Turn the cursor off when you are finished creating the remark.

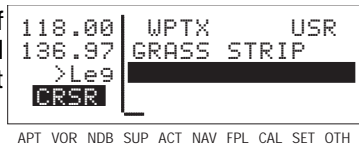

Figure 3-157

The Other 4 (OTH 4) page is a list of waypoints with associated remarks. Sometimes these are deleted if there are more than 100 waypoints with remarks, or if the remarks are no longer relevant. If you wish to delete a waypoint remark for a user-defined waypoint, see section 3.13.2.2.

3.12. VIEWING AND SETTING THE DATE AND TIME

The KLX 135A system time and date should seldom, if ever, require updating because they are automatically updated when at least one satellite is received. In addition, the KLX 135A contains an internal battery powered calendar/clock to keep system time and date when the unit is not being used. You will normally check to make sure the KLX 135A is set to the correct time and date shortly after you turn the unit on while you verify the Self Test Page. You can, however, also check the time and date on the Setup (SET) 2 page anytime you desire. There are several pages as well as some internal functions of the KLX 135A, such as magnetic variation and proper use of data base information, that depend on having the proper time and date.

NOTE: You will not be able to update the time or date if the KLX 135A is receiving a time and date from a satellite.

To set the date on the SET 2 page:

1. Select the SET 2 page (figure 3-158).
2. Turn on the cursor. The cursor will be over the entire date field (figure 3-159).
3. Select the correct day of the month with the right inner knob.
4. Move the flashing part of the cursor to the month field (middle three dashes) with the right outer knob, and select the proper month (figure 3-160).
5. Move the flashing part of the cursor to the tens digit of the year field, and select the proper number (figure 3-161).
6. Repeat step 5 for the ones digit of the year field.

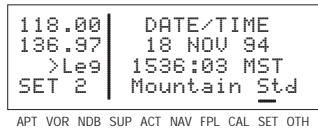

Figure 3-158

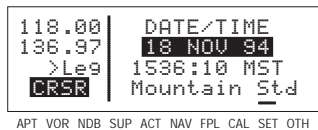

Figure 3-159

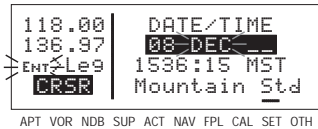

Figure 3-160

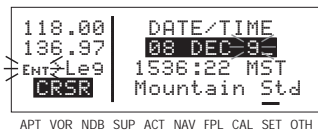

Figure 3-161

- Press **ENT** to start the KLX 135A using the newly entered date (figure 3-162).

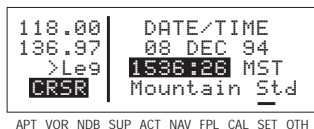

Figure 3-162

To set the time on the SET 2 page:

- Select the SET 2 page if it is not already selected.

- Turn on the cursor and move it to the time zone field (figure 3-163).

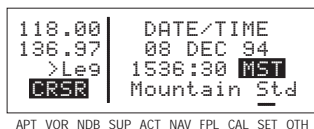

Figure 3-163

- Change the time zone with the right inner knob, if desired (figure 3-164). A listing of the time zones and their abbreviations is contained in section 3.2, "Turn-on and Self Test".

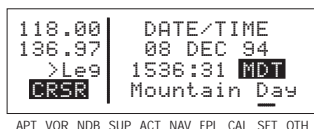

Figure 3-164

- Move the cursor to the time field. The hours and minutes will appear in inverse video.

- Select the correct hour (figure 3-165). Remember, the KLX 135A uses 24 hour time. If it is 1:00 P.M. or later, add 12 hours (for example, 2:30 P.M. becomes 14:30).

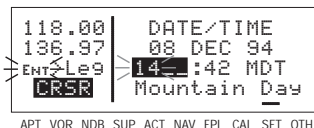

Figure 3-165

- Move the flashing part of the cursor to the tens of minutes, select the proper number (figure 3-166), then move on to the last digit and set it.

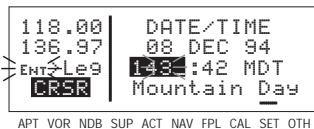

Figure 3-166

- Press **ENT** to start the clock running (figure 3-167). Note that the seconds will reset to zero when you do this.

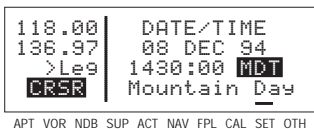

Figure 3-167

3.13. THE OTHER (OTH) PAGES

3.13.1. DETERMINING THE STATUS OF THE GPS SIGNALS

The Other (OTH) 1 and OTH 2 pages may be viewed at any time to determine the status of the GPS receiver and the GPS satellites being received. This includes which satellites are being tracked, the satellites' health, the signal-to-noise ratio for each of these satellites, the elevation of each satellite above the horizon, and the estimated position error.

The GPS receiver in the KLX 135A is capable of using signals from up to eight satellites to determine its position. A valid position may be determined using as few as four satellites alone or three satellites with a valid altitude input. However, four satellites alone or three satellites with an altitude input do not necessarily ensure that navigation can take place. The satellites must be positioned relative to your location such that sufficient "geometry" exists to determine an accurate position. The satellite constellation geometry is continually changing as each satellite, "rises", travels across the sky, and eventually "sets" relative to your position. The GPS satellites are not in geosynchronous orbits positioned over the same spot on earth at all times like some television communication satellites with which you may be familiar. Rather, the GPS satellites are in orbits that allow them to circle the earth about two times each day.

A representative OTH 1 page is shown in figure 3-168. The OTH 1 page displays the GPS receiver state and the system's estimate of the position error expressed in nautical miles.

```

118.00 | State      NAV D
136.97 |
>Le9  | Estimated Posn
OTH 1 | Error  0.02nm
    
```

APT VOR NDB SUP ACT NAV FPL CAL SET OTH

Figure 3-168

The GPS state is indicated on line 1. The possibilities are:

- INIT** initialization
- SRCH** search the sky
- ACQ** acquisition
- TRAN** transition
- NAV** navigation
- NAV A** navigation with altitude aiding
- NAV D** navigation with data collection
- DEGRD** navigation with position degradation
- FAILR** receiver failure

In the initialization state the GPS receiver is in the process of

initializing itself, collecting information such as the date, time, and last present position. Next, the receiver collects data from its own memory to determine which satellites should be visible. After completing the initialization process the receiver begins the acquisition process. During this time, the visible satellites are being acquired and data is obtained from them.

If the KLX 135A is not used for a period of six months or more, the satellite orbital data stored in the GPS receiver's memory is too old to use. When this occurs, the receiver will enter the search the sky state to acquire the required data. This data, called almanac data, can be acquired by receiving just one satellite. A search the sky operation takes 20 minutes to complete.

The transition state indicates an adequate number of satellites for navigation has been acquired and is being tracked but no position data can yet be produced.

Normal navigation is indicated by a **NAV**, **NAV A**, or **NAV D** GPS state. **NAV A** indicates that the altitude input is being used in the position solution. **NAV D** indicates that besides calculation position, the receiver is collecting and storing in its memory additional data from the satellites (called ephemeris and almanac data).

Lines 3 and 4 of the OTH 1 page display the KLX 135A's estimated position error. The KLX 135A's position error depends upon such factors as the number of satellites being received, the strength of the GPS signals, and the geometry of the satellites presently being used for navigation.

Figures 3-169, 3-170 and 3-171 show a representative example of a set of OTH 2 pages. There will be three OTH 2 pages if more than six satellites are being received as in this example. The following information is displayed for each satellite on the OTH 2 pages:

- The specific GPS satellites or "space vehicles" (**SV**) being received are displayed in the left column. Each satellite has its own identification number. A * symbol to the right of the satellite

118.00	SV	Hlt	SNR	Ele
136.97	02	Good	41	43°
>Le9	11	Good	32	07°
OTH+2	16*	Weak	31	76°

APT VOR NDB SUP ACT NAV FPL CAL SET OTH

Figure 3-169

118.00	SV	Hlt	SNR	Ele
136.97	18	Good	39	21°
>Le9	20	Good	47	88°
OTH+2	23*	Good	34	09°

APT VOR NDB SUP ACT NAV FPL CAL SET OTH

Figure 3-170

118.00	SV	Hlt	SNR	Ele
136.97	25	Good	41	52°
>Le9				
OTH+2				

APT VOR NDB SUP ACT NAV FPL CAL SET OTH

Figure 3-171

number indicates this particular satellite is not presently being used in the navigation position solution.

- The satellite's "health" (**Hlt**) is indicated to the right of the satellite number. This health information is transmitted by the satellites.
- The signal-to-noise ratio (**SNR** in decibels) for each satellite is displayed in the middle column and indicates the signal strength for each satellite. The higher the SNR value the stronger the signal. Values usable for navigation will be in the mid 30s to mid 50s; however, typical values are in the middle of this range.
- The elevation (**Ele**) above the horizon for each satellite is provided in the right column and will range from 5° to 90°.

3.13.2. VIEWING AND DELETING USER WAYPOINTS AND WAYPOINT REMARKS

The OTH 3 and OTH 4 pages list the user-defined waypoints and waypoint remarks, respectively, which are currently stored in the KLX 135A's memory.

3.13.2.1. The OTH 3 Page

An example of an OTH 3 page is shown in figure 3-172. All currently stored user-defined waypoints are listed in alphanumeric order. If the user-defined waypoint is the active waypoint, an arrow (➔) follows the identifier. If the waypoint is used in one or more flight plans, then the number of the first flight plan in which it is used is displayed on the right side. If there are more than three user waypoints in storage, you can see the rest of the list by turning on the cursor (**CRSR**) and turning the right outer knob to scroll through the list.

118.00	User Waypoints	
136.97	LAKE	
>Le9	MVRWY	0
OTH+3	WPTX	5

APT VOR NDB SUP ACT NAV FPL CAL SET OTH

Figure 3-172

To delete a user-defined waypoint from the OTH 3 page:

1. Turn on the cursor and position it over the desired waypoint (figure 3-173). If there are more than three user-defined waypoint, you will have to scroll the cursor down the list.

118.00	User Waypoints	
136.97	LAKE	
>Le9	MVRWY	0
CRSR	WPTX	5

APT VOR NDB SUP ACT NAV FPL CAL SET OTH

Figure 3-173

Basic GPS Operation

- Press **CLR**. The KLX 135A will ask if you wish to delete that user-waypoint (figure 3-174). If the waypoint is active or used in a flight plan, the deletion will not be allowed and you will receive a scratchpad message telling you this (figure 3-175).

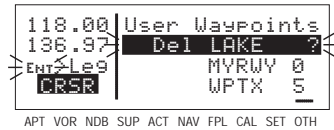

Figure 3-174

- Press **ENT** to approve the deletion (figure 3-176).

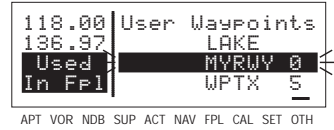

Figure 3-175

3.13.2.2. The OTH 4 Page

An example of an OTH 4 page is shown in figure 3-177. All waypoints with remarks are listed in alphanumeric order. Remarks can be stored for airports (on the APT 5 page) or user-defined waypoints (on the SUP 3 page). If the waypoint is an airport, then an “A” is displayed on the right side; likewise, a “U” represents a user-defined waypoint.

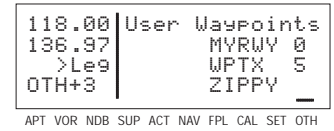

Figure 3-176

If there are more than three waypoints, you can see the rest of the list by turning on the cursor (**CRSR**) and turning the right outer knob to scroll through the list.

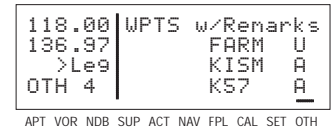

Figure 3-177

To delete a waypoint remark from the OTH 4 page:

- Turn on the cursor and position it over the desired waypoint (figure 3-178). If there are more than three airports with remarks, you will have to scroll the cursor down the list.
- Press **CLR**. The KLX 135A will ask if you wish to delete that remark (figure 3-179).
- Press **ENT** to approve the deletion.

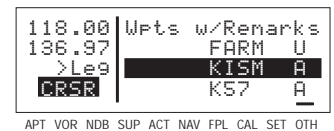

Figure 3-178

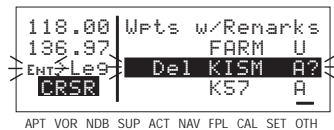

Figure 3-179

3.13.3. VIEWING THE KLX 135A SOFTWARE STATUS

The OTH 5 page (figure 3-180) shows the software revision status of the KLX 135A host computer (line 2), the GPS receiver (line 3), and data base (line 4).

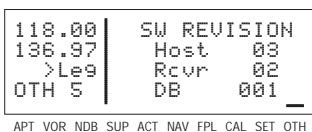

Figure 3-180

3.14. REMOTE MOUNTED ANNUNCIATORS

The KLX 135A has outputs capable of driving two remote annunciator lights: waypoint alert and message. Although these annunciators are optional, it is desirable to have them mounted in the pilot's normal scan area so that these annunciators are easily seen. A typical annunciator is shown in figure 3-181; however, actual annunciation abbreviations and configurations may be different.



Figure 3-181

The remote waypoint alert annunciator is on whenever waypoint alerting is occurring. See sections 3.9.3, "Waypoint Alerting for Direct To Operation" and 4.2.2, "Turn Anticipation and Waypoint Alerting".

The remote message annunciator is on whenever the message prompt is on. See section 3.5.

3.15. SPECIAL USE AIRSPACE ALERTING

The KLX 135A data base contains the location of areas of special use airspace (SUA). The types of SUA areas stored in the data base and the abbreviations used to denote these areas are the following:

Class B	CL B
Class C	CL C
Control Area (used outside USA)	CTA
Terminal Area (used outside USA)	TMA
Alert Area	ALRT
Danger Area	DNGR
Prohibited Area	PROH
Restricted Area	REST
Terminal Radar Service Area	TRSA

NOTE: The KLX 135A data base does not include Military Operations areas (MOAs), Warning areas, Training areas or Caution areas.

The KLX 135A will normally alert you prior to entering one of these areas with a message prompt. When the Message page is viewed it will display Airspace Alert and will also display the name and type of the special use airspace (figure 3-182). If the special use airspace is a Class B, Class C, CTA, or TMA, the message page will also instruct you to press the **CLR** button if you wish to see the Airport 4 page (airport communications) for the primary airport so that the correct communications frequency may be determined (figure 3-183).

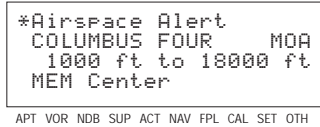

Figure 3-182

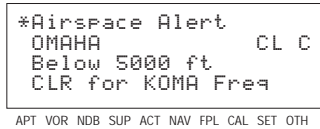

Figure 3-183

NOTE: In addition to the message page messages that alert you to special use airspace, the KLX 135A can also display the five nearest areas of SUA. It will even give you the direction and distance to the nearest edge of the SUA. See section 3.8.2 for more details.

The SUA alert feature is three dimensional. The SUA areas are stored in the KLX 135A data base with regard to altitude when the actual SUA altitude limitations are charted in terms of mean sea level (MSL). Therefore, if you are flying either above or below an SUA area you won't be inconvenienced with nuisance alert messages. However, if the actual lower limit of an SUA is charted in terms of an altitude above ground level (AGL), then it is stored in the KLX 135A as all altitude below the upper limit of the SUA. If the actual upper limit of an SUA is charted in terms of AGL, it is stored in the KLX 135A as "unlimited".

Since the altitude input to the KLX 135A is pressure altitude from an altitude encoder, you must manually update the KLX 135A with an altimeter setting (baro correction) in order to receive accurate SUA alerting. You may easily update the altimeter setting by selecting the SET 8 page (figure 3-184) The right inner knob is used to change the altimeter setting. When the setting is complete, turn off the cursor.

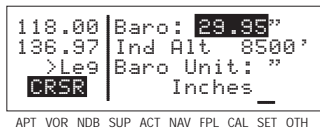

Figure 3-184

CAUTION: Failure to keep the altimeter baro setting updated will result in inaccurate special use airspace alerting. If this feature is used, it is a good idea to update the altimeter baro setting on the SET 8 page each time you make a change to an aircraft's altimeter setting.

NOTE: If there is no altitude input to the KLX 135A, all altitudes will be regarded as being within the boundary of the SUA area.

Only the outer lateral boundaries are stored for Class B, Class C, CTA, and TMA airspace. These SUA areas are stored as “cylinders” of airspace so all altitudes below the upper limit of these areas are considered to be in the SUA.

The message prompt for a special use airspace alert will occur when the aircraft's position is at a point such that a projection of the aircraft's existing track over the ground is approximately 10 minutes from penetrating the outer boundary of one of these areas. It will also occur if the aircraft is within approximately two nautical miles of one of these areas even if the aircraft's projected track over the ground won't actually penetrate the SUA area (figure 3-185). If one of the SUA areas is penetrated, another message will state: **Inside SUA.**



Figure 3-185

The SUA alert feature may be disabled (or enabled) on the Setup 7 (SET 7) page, shown in figure 3-186. Select the SET 7 page, turn on the cursor (**CRSR**). The right inner knob is used to choose between **SUA ALERT ENABLED** and **SUA ALERT DISABLED**.

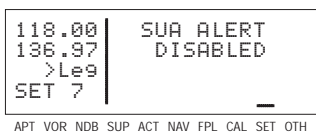

Figure 3-186

If the SUA alert feature has been enabled, the KLX 135A allows you to select a vertical buffer on the SET 7 page in order to provide an additional layer of protection from inadvertently entering an SUA. To select a vertical buffer, make sure the SUA alert feature has been enabled. Turn on the cursor (**CRSR**) (figure 3-187) and then use the right inner

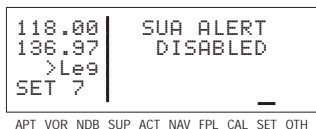

Figure 3-187

knob to select the buffer (figure 3-188). The buffer may be selected in one hundred foot increments. After the desired selection has been made, turn the **CRSR** off.



Figure 3-188

The vertical buffer serves to “stretch” the SUA area in both directions (up and down) by the selected buffer altitude. For example, let’s say you have selected a buffer of 1,000 feet and the actual SUA area exists from 5,000 feet MSL to 12,000 feet MSL. In this case you will receive SUA alert messages if you fly at any altitude between 4,000 and 13,000 feet MSL.

CAUTION: It is the pilot’s responsibility to avoid those areas of special use airspace where ATC clearance to penetrate is required but has not been obtained. The KLX 135A’s special use airspace alert is only a tool to assist the pilot and should never be relied upon as the sole means of avoiding these areas.



3.16 SAMPLE TRIP

We’ve talked a lot about the features of the KLX 135A, and now it’s time to put those features to work for us and try a sample trip! Our trip will be from Adams field (KLIT) in Little Rock, Arkansas to Mueller Municipal airport (KAUS) in Austin, Texas. The weather is perfect and we decide to make trip VFR and fly direct to Austin.





3.16.1 PRE-DEPARTURE

1. Apply power to the KLX 135A by rotating the ON/OFF/VOLUME knob clockwise, being careful how far you turn up the audio volume.
2. Verify that the information on the Self Test and Initialization pages is correct, including the time and date. Enter the altimeter baro setting. Position the cursor over **Ok?** and press **ENT** to approve the Initialization page.
3. Read the Data Base page and acknowledge it by pressing **ENT**.
4. The APT 4 page for Adams field (**KLIT**), which shows the communications frequencies, is now displayed on the screen since **KLIT** was the active waypoint when you last removed power from the KLX 135A. The first APT 4 page indicates that the ATIS fre-

quency is 125.65 MHz, the pre-taxi clearance delivery frequency is 118.95 MHz, and the ground control frequency is 121.90 MHz. You use QuickTune™ to select ATIS and clearance delivery into the active and standby frequencies, respectively. After listening to ATIS, we contact clearance delivery for our clearance out of the Little Rock Class C airspace. Next, we give ground control a call and receive our taxi clearance.

5. By this time the KLX 135A has reached a NAV ready status. We can verify this by turning to the NAV 2 page. It shows a valid present position, in this case 3.8 nautical miles on the 320 degree radial from Little Rock (LIT) VOR.
6. Press  to bring up the Direct To page. Use the right inner and outer knobs to enter the identifier of Mueller Municipal airport (KAUS) by using the right inner knob to select the characters and the right outer knob to move the flashing part of the cursor to the desired cursor location.
7. Press . The APT 1 page for Mueller Municipal is now displayed on the screen.
8. Press  again to approve the waypoint page. The NAV 1 page is now displayed. The NAV 1 page indicates it is 384 nautical miles to Austin and that the bearing is 225 degrees. After take-off, the NAV 1 page will also display groundspeed and estimated time en route.

3.16.2 EN ROUTE

1. We depart from runway 36 at Little Rock and are told to “maintain runway heading.” After several radar vectors for traffic avoidance we are finally cleared on course. The D-Bar indicates that the radar vectors have taken us north of the original course and we decide to proceed Direct To Austin from our present position. To recenter the D-Bar, press , and then press .
2. After departure control has directed “squawk 1200, frequency change approved,” you decide it would be a good idea to obtain VFR flight following. To obtain the frequency for Center, press the  and  buttons, move the cursor to the **CTR?** selection, and press . The KLX 135A indicates that for our position, we should be able to contact Memphis Center on 118.85 MHz. Again, you use QuickTune™ to select Memphis Center on the KLX 135A COMM.

3. We've only flown about 100 nautical miles, but we begin wondering where we would go if an engine suddenly started running rough. We decide to use the KLX 135A to determine where the nearest airports are from our present location. To view the nearest airports press **[MSG]** and then press **[ENT]** twice. The nearest airport is Hope Municipal (**M18**) which is eight nautical miles from our position on a bearing to the airport of 11 degrees. You now rotate the right inner knob to view the other APT pages for Hope Municipal. We learn, for example, that it is located in Hope, Arkansas, and has two hard surface runways that are each 5500 feet in length. By pulling the right inner knob to the "out" position, you may now scan clockwise through the remaining eight airports in the nearest airport list.
4. For the majority of the en route portion of the flight, you select the NAV 5 page's moving map display. Pressing the right **[CRSR]** button, you select the 30 nautical mile range scale using the right inner knob. Moving the cursor to **Menu?** And pressing **[ENT]** brings up the display menu on the screen. You then use the right knobs to select **APT:on** and **SUA:on** so that nearby airports and special use airspace (SUA) are shown on the moving map display. While the menu is displayed, select the track up map orientation (**TK**) as well, Pressing the **[CRSR]** button again removes the menu from the screen.
5. Since it is a good idea to not rely on just one navigation source, we suggest you cross check the KLX 135A position against other equipment in the aircraft. The NAV 2 page indicates we are presently located on the Texarkana (**TXK**) VOR 68 degree radial at a distance of 19 nautical miles. By tuning our NAV receiver and DME to **TXK**, we are able to confirm that this is the correct position.

3.16.3 TERMINAL AREA

1. About 50 nautical miles from Austin's Mueller airport we start preparing for our arrival. Viewing the APT 4 page for **KAUS** you determine that the ATIS frequency is 119.20 MHz and tower is 121.00 MHz, and QuickTune™ these frequencies to the COMM.
2. A few minutes later, the message prompt begins flashing. When you press **[MSG]**, the message page advises **Airspace Alert - Austin CL C - Below 4600 ft - CLR for KAUS Freq.** The Special Use Airspace Alert feature has determined that you are within 10 minutes of penetrating the Austin Class C airspace.

When you press **CLR** and view the APT 4 page for KAUS, you see that the Class C airspace frequencies are sectorized. You determine from the APT 4 page that the proper frequency to use is 124.90 MHz since we are Northeast of Austin and 124.90 MHz is the appropriate frequency to use from 3 degrees to 170 degrees. You turn to the NAV 5 page so that we can see the outer boundary of the Austin Class C airspace relative to our location and route.

3. After you call Austin approach control for clearance into the Class C airspace, you view the rest of the APT pages for KAUS to determine the field elevation and available runways.
4. After landing, the KLX 135A is turned off either by rotating the KLX 135A power knob counterclockwise (to OFF), or with the avionics master switch if one is installed.

This page intentionally left blank

4. ADVANCED GPS OPERATION

4.1. CREATING AND MODIFYING FLIGHT PLANS

The following rules and considerations apply to KLX 135A flight plans:

- The KLX 135A is capable of storing in its memory nine flight plans plus an active flight plan.
- Each of the flight plans may contain up to 20 waypoints. The waypoints may consist of any combination of published waypoints from the data base or user created waypoints.
- The flight plans are numbered 0 through 9 (FPL 0, FPL 1, FPL 2, . . . , FPL 9).
- The active flight plan is **always** FPL 0. The standard procedure is to create a flight plan in one of the flight plans numbered as FPL 1, FPL 2, etc. When one of these numbered flight plans is activated, it becomes FPL 0, the active flight plan. This Pilot's guide will refer to FPL 0 as the "active flight plan" and FPL 1 through FPL 9 as the "numbered flight plans." If desired, a flight plan can be created directly in the active flight plan. This avoids creating the flight plan in a numbered flight plan and then having to activate it. The disadvantage is that if a numbered flight plan is subsequently made active, the one programmed directly into FPL 0 will be lost.
- Modifications may be made to FPL 0 without affecting the way it is stored as a numbered flight plan.
- Unless Direct To operation is being used, the active flight plan (FPL 0) must contain at least two waypoints. Otherwise, the KLX 135A navigation system will be flagged.

4.1.1. CREATING A FLIGHT PLAN

A flight plan for a flight from Lakefront airport in New Orleans, LA. to St. Petersburg/Clearwater, FL. International airport will be used as an example of how to create a flight plan. The waypoints making up the flight plan are: **KNEW** (Lakefront airport), **GPT** (Gulfport VOR), **SJI** (Semmes VOR), **CEW** (Crestview VOR), **MAI** (Marianna VOR), **TLH** (Tallahassee VOR), **CTY** (Cross City VOR), and **KPIE** (St. Petersburg/Clearwater International airport).

To create a flight plan:

1. Select the flight plan (FPL) pages with the right outer knob.

2. Select a flight plan page (preferably other than FPL 0) which does not contain a flight plan (figure 4-1). If all of the flight plan pages contain flight plans, refer to section 4.1.6, "Deleting Flight Plans".

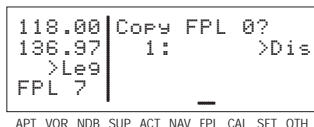

Figure 4-1

3. Turn on the cursor (CRSR).

NOTE: The KLX 135A flight plan operation is designed so that the first waypoint in the flight plan should always be the departure point. Remember to enter the **K**, **P**, or **C** prefix for certain airports in the United States, Alaska (some, but not all cases), or Canada, respectively. See section 2.3, "ICAO Identifiers".

4. Use the right inner knob to select the first character of the departure waypoint identifier (figure 4-2). If you have set the default first waypoint character to **K** on the SET 5 page, you will just need one turn clockwise (see section 3.4.2, "Data Entry")

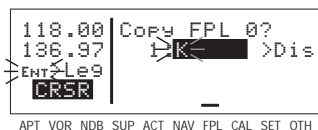

Figure 4-2

5. Turn the right outer knob to move the flashing part of the cursor over the second character, then select the desired character.

6. Use the above procedure to select the entire identifier for the first waypoint (figure 4-3).

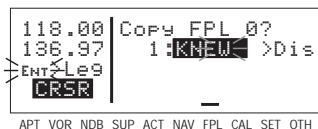

Figure 4-3

7. Press **ENT**. A waypoint page for the identifier just entered will be displayed on the screen (figure 4-4). If a mistake was made and the wrong waypoint identifier was entered, press **CLR** and begin again. If no mistake was made but the waypoint identifier just entered isn't in the data base, a page allowing creation of a user



Figure 4-4

defined waypoint will appear on the screen. Refer to section 4.4 for instructions on how to create a user-defined waypoint.

8. Press **ENT** again to approve the waypoint page being displayed. The cursor will move automatically to the second waypoint position (figure 4-5).

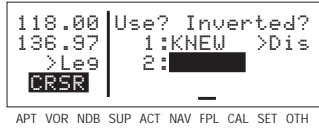

Figure 4-5

9. Use the same procedure to enter the rest of the waypoints in the flight plan (figure 4-6). If the flight plan consists of three or more waypoints, the waypoints will automatically scroll as necessary to allow entry of the next waypoint.

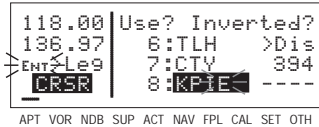

Figure 4-6

10. When all of the waypoints have been entered in the flight plan, the right outer knob may be rotated to move the cursor up and down and manually “scroll” through the waypoints making up this flight plan. This is useful if the flight plan contains four or more waypoints since not all of the waypoints can be displayed at one time. When the right outer knob is rotated counterclockwise, the cursor may be positioned over **Use?**. If there are more than three waypoints in the flight plan, the first two waypoints will then be displayed followed by the last waypoint in the flight plan. Rotate the right outer knob to move the cursor and manually scroll to see the missing intermediate waypoints.
11. Turn off the cursor (**CRSR**). Additional flight plans may now be created in the same manner.

4.1.2. VIEWING DISTANCE AND DESIRED TRACK BETWEEN STORED FLIGHT PLAN WAYPOINTS

The stored flight plan (FPL 1-9) pages have a field to the right of each waypoint in the flight plan. This field may be used to display the cumulative distance (**Dis**) to each waypoint or the magnetic desired track (**Dtk**) from the previous waypoint.

If you have more than three waypoints in the stored flight plan, you may wish to view flight data for waypoints which are not displayed on the screen. If this is the case, turn on the cursor (**CRSR**) and use the right outer knob to scroll down the flight plan until the waypoint of interest is on the screen.

This display will default to the distance presentation at power-on. The area in the upper right hand corner of the screen is a cyclic field.

To cycle between distance and desired track display on a numbered flight plan page:

1. Turn on the cursor (**CRSR**); it will come up over the cyclic field, which in this case is displaying distance (**Dis**) in nautical miles (figure 4-7).
2. Press **CLR**. The cyclic field will change to magnetic desired track (**Dtk**) (figure 4-8). An additional **CLR** press cycles back to **Dis**.

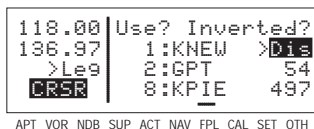

Figure 4-7

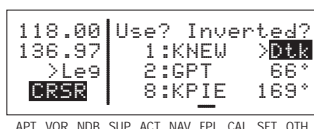

Figure 4-8

4.1.3. ACTIVATING A NUMBERED FLIGHT PLAN

To activate one of the previously created numbered flight plans:

1. Use the right outer and inner knobs to select the desired flight plan page (figure 4-9).
2. Press **CRSR** to turn on the cursor. It will appear over **Use?** (figure 4-10). If you haven't left the numbered flight plan since creating this flight plan, rotate the outer knob counterclockwise to position the cursor over **Use?**
3. Press **ENT** to activate the flight plan in the order shown (figure 4-11). To activate the flight plan in inverse order (first waypoint becomes last and last waypoint becomes first), rotate the outer knob one step clockwise to position the cursor over **Use? Inverted?** before pressing **ENT** (figure 4-12).

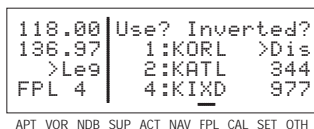

Figure 4-9

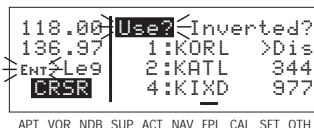

Figure 4-10



Figure 4-11



Figure 4-12

- The selected flight plan is now displayed as FPL 0, the active flight plan. Any changes made to FPL 0 will not affect how this flight plan is stored as the numbered flight plan.

4.1.4. ADDING A WAYPOINT TO A FLIGHT PLAN

A waypoint may be added to any flight plan containing fewer than 20 waypoints

To add a waypoint to a flight plan:

- Turn on the cursor with the **CRSR** button.
- With the outer knob, position the cursor over the waypoint identifier which you desire to follow the waypoint being added. Another way to think of this is to position the cursor over the location in the flight plan you wish the new waypoint to be added. For example, if **SJI** is presently the second waypoint in the flight plan and you wish to insert **GPT** in the number 2 position in front of **SJI**, move the cursor over **SJI** (figure 4-13).

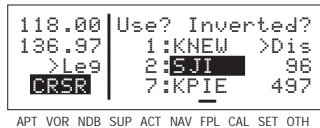

Figure 4-13

- Use the inner knob to enter the first character of the waypoint being inserted. As you begin to turn the knob, the existing waypoint in this position automatically jumps down to the next position. In this case, **SJI** automatically moves to waypoint 3 and **KPIE** changes to waypoint 8 (figure 4-14).

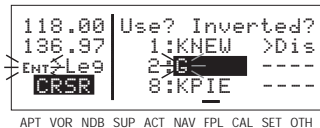

Figure 4-14

- Complete the waypoint entry operation (figure 4-15).

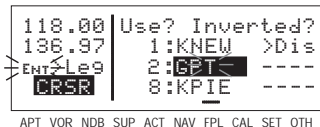

Figure 4-15

- Press **ENT** to display the waypoint page on the right side for the identifier just entered (figure 4-16).

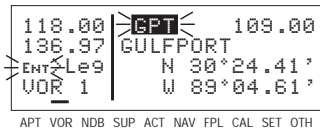

Figure 4-16

- Press **[ENT]** again to approve the waypoint page (figure 4-17).

```

118.00 | Use? Inverted?
136.97 | 2:GPT >Dis
>Leg   | 3:SJI 96
CRSR   | 8:KPIE 497
    
```

APT VOR NDB SUP ACT NAV FPL CAL SET OTH

Figure 4-17

- Turn off the cursor (**[CRSR]**).

4.1.5. DELETING A WAYPOINT FROM A FLIGHT PLAN

To delete a waypoint from a flight plan:

- Press **[CRSR]** to enable the cursor if it is not on already.

- Move the cursor over the waypoint you wish to delete (figure 4-18).

```

118.00 | Use? Inverted?
136.97 | 3:SJI >Dis
>Leg   | 4:CEW 183
CRSR   | 8:KPIE 497
    
```

APT VOR NDB SUP ACT NAV FPL CAL SET OTH

Figure 4-18

- Press **[CLR]**. The letters **Del** (delete) will appear to the left of the identifier and a question mark will appear to the right of the identifier (figure 4-19). If a mistake was made and you do not wish to delete this waypoint, press **[CLR]**.

```

118.00 | Use? Inverted?
136.97 | 3:SJI >Dis
?Del?Leg | 4:CEW 183
CRSR   | 8:KPIE 497
    
```

APT VOR NDB SUP ACT NAV FPL CAL SET OTH

Figure 4-19

- Press **[ENT]** and the waypoint will be deleted from the flight plan. The other waypoints in the flight plan will be correctly repositioned (figure 4-20).

```

118.00 | Use? Inverted?
136.97 | 3:SJI >Dis
>Leg   | 4:MAI 263
CRSR   | 7:KPIE 497
    
```

APT VOR NDB SUP ACT NAV FPL CAL SET OTH

Figure 4-20

- Turn off the cursor (**[CRSR]**).

4.1.6. DELETING FLIGHT PLANS

To delete a flight plan which is no longer required:

- Display the flight plan (FPL 0, FPL 1, . . . , or FPL 9) which is to be cleared (figure 4-21).
- Make sure that the cursor is turned off, and use the **[CRSR]** button if it is not.

```

118.00 | Use? Inverted?
136.97 | 1:KNEW >Dis
>Leg   | 2:GPT 54
FPL 7  | 7:KPIE 497
    
```

APT VOR NDB SUP ACT NAV FPL CAL SET OTH

Figure 4-21

- Press **CLR**. The words **Delete FPL?** will appear at the top of the page (figure 4-22). If a mistake was made and you do not wish to clear this flight plan, press **CLR** again.

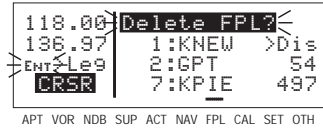

Figure 4-22

- Press **ENT** to clear the flight plan (figure 4-23).

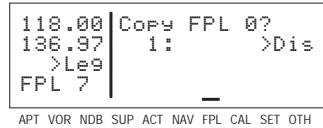

Figure 4-23

4.1.7. STORING FPL 0 AS A NUMBERED FLIGHT PLAN

The active flight plan may be loaded into a numbered flight plan so that it can be recalled for later use. This may be desirable, for example, if the active flight plan was originally created on the FPL 0 page and not as a numbered flight plan.

To store the active flight plan as a numbered flight plan:

- Select a numbered flight plan page which does not contain any waypoints (figure 4-23). If none exist, use the procedure described in section 4.1.6, "Deleting Flight Plans," to clear a flight plan which is no longer required.

- Turn on the cursor (**CRSR**). It will appear over the blank first waypoint position (figure 4-24).

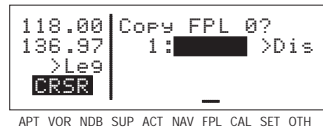

Figure 4-24

- Rotate the right outer knob counterclockwise to position the cursor over **Copy FPL 0?** (figure 4-25).

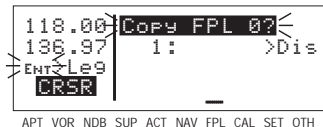

Figure 4-25

- Press **ENT** to load the active flight plan into this numbered flight plan (figure 4-26).

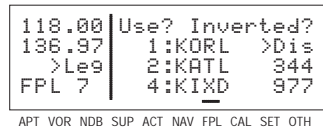

Figure 4-26

4.2. OPERATING FROM THE ACTIVE FLIGHT PLAN

4.2.1. GENERAL PROCEDURES

Everything you have learned in this Pilot's Guide thus far is applicable to using the KLX 135A for flight plan operation. The following rules and considerations apply for flight plan operation while the KLX 135A is in the En route-Leg mode:

- Always verify that you are viewing the active flight plan page (FPL 0) and not one of the other numbered flight plan pages.
- The active leg of the flight plan is designated with a ↙ symbol. A leg is defined as the course line between a pair of waypoints (a "from" waypoint and a "to" waypoint). The head of the arrow is positioned to the left of and points to the active "to" waypoint. In figure 4-27, SLC (Salt Lake City VOR) is the "to" waypoint. The tail of the ↙ symbol is positioned to the left of the "from" waypoint. KPVU (Provo Municipal) is the "from" waypoint in figure 4-27. The ↙ symbol is not displayed unless the KLX 135A is actually receiving GPS signals suitable for navigation. (**Note:** If the unit is in the take-home mode, it has been "tricked" into thinking it is receiving signals and therefore the ↙ symbol can be displayed). Also, the ↙ symbol will not be displayed if Direct To navigation is occurring and the Direct To waypoint is not in FPL 0. If in doubt as to whether or not Direct To operation is occurring, view the NAV 1 page. If the top line shows the B➔ symbol (figure 4-28) instead of a "from" waypoint (figure 4-29), then Direct To navigation is occurring. If it is desired to cancel the Direct To operation and operate from the active flight plan, press **▶**, **CLR**, and then **ENT**.

118.00	↙	1:KPVU	>Dis
136.97	↙	2:SLC	40
>Leg		3:OGD	63
FPL 0		6:KPIH	168

APT VOR NDB SUP ACT NAV FPL CAL SET OTH

Figure 4-27

unless the KLX 135A is actually receiving GPS signals suitable for navigation. (**Note:** If the unit is in the take-home mode, it has been "tricked" into thinking it is receiving signals and therefore the ↙ symbol can be displayed). Also, the ↙ symbol will not be displayed if Direct To navigation is occurring and the Direct To waypoint is not in FPL 0. If in doubt as to whether or not Direct To operation is occurring, view the NAV 1 page. If the top line shows the B➔ symbol (figure 4-28) instead of a "from" waypoint (figure 4-29), then Direct To navigation is occurring. If it is desired to cancel the Direct To operation and operate from the active flight plan, press **▶**, **CLR**, and then **ENT**.

118.00		B➔	SLC
136.97	>	++++▲++++	
>Leg		26.1nm	109kt
NAV 1	>	338°To	0:14

APT VOR NDB SUP ACT NAV FPL CAL SET OTH

Figure 4-28

118.00		KPVU	+ SLC
136.97	>	++++▲++++	
>Leg		26.1nm	109kt
NAV 1	>	338°To	0:14

APT VOR NDB SUP ACT NAV FPL CAL SET OTH

Figure 4-29

- As flight plan waypoints are reached, the active leg symbol automatically shifts to the next leg.
- If the flight plan contains more waypoints than can be displayed on the screen at one time, the page will automatically scroll as progress is made along the flight plan so that the active leg is always displayed (figure 4-30).

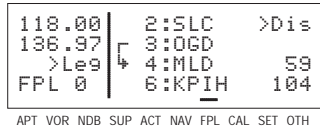

Figure 4-30

- The last waypoint in the flight plan is always displayed at the bottom of the FPL 0 page, even if all of the waypoints in the flight plan can't be displayed on the page at one time. To view intermediate waypoints, turn the cursor on and use the right outer knob to manually scroll through all of the waypoints, as desired. If scrolling is performed all the way to the end of the flight plan, a blank waypoint position will exist so that a waypoint may be added to the end of the flight plan (figure 4-31).

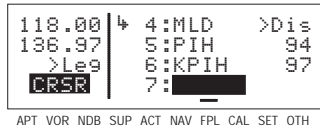

Figure 4-31

4.2.2. TURN ANTICIPATION AND WAYPOINT ALERTING

Prior to reaching a waypoint in the active flight plan, the KLX 135A will provide navigation along a curved path segment to ensure a smooth transition between two adjacent legs in the flight plan. That is, the CDI or HSI left/right deviation will be referenced to the dashed line in figure 4-32. This feature is called turn anticipation. The transition course is based upon the aircraft's actual groundspeed and the amount of course angle change between the two legs. The KLX 135A automatically sequences to the next leg after passing the midpoint in the transition segment.

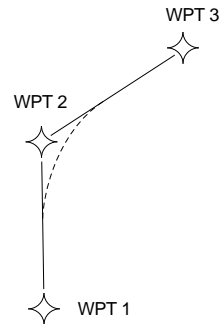

Figure 4-32

Approximately 20 seconds prior to the beginning of turn anticipation, the arrow preceding the active waypoint identifier will begin flashing on the FPL 0 page and on any Navigation page or waypoint page displaying the active waypoint identifier (figures 4-33 and 4-34). This is called “waypoint alerting”. If an external waypoint alert annunciator is mounted in the aircraft, this annunciator will begin flashing at the same time.

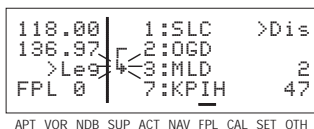

Figure 4-33

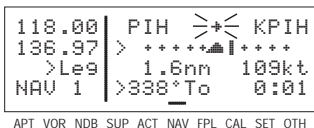

Figure 4-34

To utilize the turn anticipation feature, start the turn transition to the next leg in the flight plan at the very beginning of turn anticipation. This occurs when the external waypoint alert annunciator stops flashing and goes on steady. At this time, the KLX 135A will notify you with a message on the Message page of the new desired track to select on your HSI or CDI.

*Adj Nav Crs to 123°

A message will not be given if the change in desired track (course change) is less than 5°.

The desired track (**Dtk**) displayed on the NAV 5 page also changes to the value for the next leg at the beginning of turn anticipation. Turn anticipation becomes inactive when transition to the next leg has been made.

If desired, turn anticipation may be disabled (or enabled) on the Setup (**SET**) 4 page by pressing the **CRSR** button and then using the right inner knob to switch back and forth between **ENABLED** (figure 4-35) and **DISABLED** (figure 4-36). If turn anticipation is disabled, navigation is provided all the way to the waypoint, and waypoint alerting occurs approximately 36 seconds prior to actually reaching the waypoint.

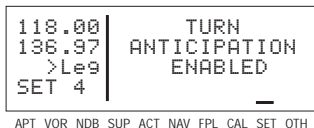

Figure 4-35

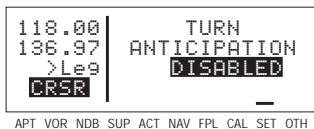

Figure 4-36

4.2.3. VIEWING THE WAYPOINT PAGES FOR THE ACTIVE FLIGHT PLAN WAYPOINTS

The waypoint pages for each of the waypoints in the active flight plan may be easily displayed by selecting the Active (ACT) Waypoint page type. When the ACT page type is first selected, the waypoint page for the active waypoint will be displayed (figure 4-37). The location of the waypoint in the flight plan (waypoint 1, waypoint 2, etc.) is announced with a number to the left of the identifier. In addition, an arrow to the left of the waypoint number designates the active waypoint. If there is a **U** to the far right of the identifier, it designates the waypoint as a user-defined waypoint. If the waypoint is an airport, the field elevation is displayed here. If the waypoint is a VOR or an NDB, the navaid frequency is displayed in this area (figure 4-38).

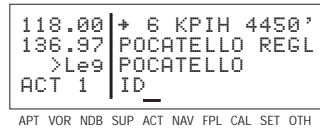

Figure 4-37

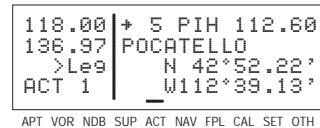

Figure 4-38

To view the waypoints in the flight plan that are not the active waypoint:

1. Pull the right inner knob to the "out" position and turn it to view each of the waypoints in the order they are contained in the flight plan (figure 4-39).

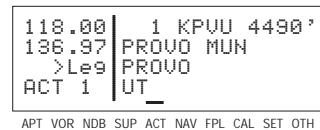

Figure 4-39

2. Once the desired waypoint is found, the right inner knob may be pushed back to the "in" position and rotated to display any of the other waypoint pages (figure 4-40).

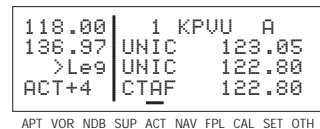

Figure 4-40

3. Pulling the knob back out will allow further scanning of the waypoint pages in the active flight plan.

4.2.4. COMBINING DIRECT TO AND FLIGHT PLAN OPERATION

It is very common when using flight plan operation to use the Direct To function to proceed directly to a waypoint which exists in the

active flight plan. For example, after takeoff, it is common to receive vectors in the terminal area and then be given a clearance direct to the first point in the flight plan that was filed. The KLX 135A makes this kind of operation very easy to accomplish. Whenever you do a Direct To operation to a waypoint which is in the active flight plan (FPL 0), the system will provide navigation to the waypoint and then automatically resume navigation along the flight plan when the Direct To waypoint is reached. Waypoints which exist prior to the Direct To waypoint in the active flight plan are bypassed. Of course, the active flight plan will never be resumed if the Direct To operation is to a waypoint which is not in the active flight plan.

Any of the several methods previously described for initiating Direct To operation may be used, although the one below is the easiest for this application.

To fly direct to a waypoint in the active flight plan (FPL 0):

1. Select the FPL 0 page.
2. Turn on the cursor (CRSR) and use the left outer knob to position the cursor over the desired waypoint (figure 4-41).
3. Press **ENT**. The display will change to the Direct To Page (figure 4-42), with the identifier of the selected waypoint.
4. Press **ENT** to approve the Direct To. The NAV 1 page will be displayed (figure 4-43) reflecting the new active waypoint.
5. If you now turn back to the FPL 0 page, you will see that the active waypoint is now preceded by an arrow only, instead of the **↓** symbol (figure 4-44). This is because there is no "from" waypoint in the flight plan.

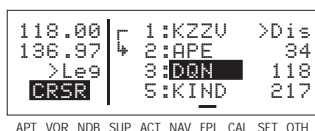

Figure 4-41

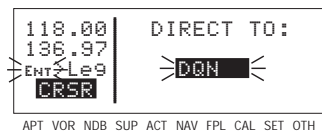

Figure 4-42



Figure 4-43

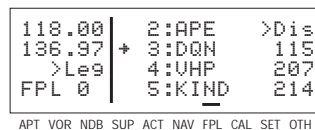

Figure 4-44

If it is desired to cancel the Direct To operation prior to reaching the Direct To waypoint in order to proceed along the flight plan leg, press **ENT**, then press **CLR**, then **ENT**.

4.2.5. VIEWING DISTANCE, ETE, ETA, OR DESIRED TRACK TO FLIGHT PLAN WAYPOINTS

The active flight plan (FPL 0) page has a data field to the right of each waypoint in the flight plan. This field may be used to display the cumulative distance (**Dis**) from the present position to each waypoint, the estimated time en route (**ETE**), the estimated time of arrival (ETA, for which the time zone abbreviation is displayed), or the magnetic desired track (**Dtk**) between each waypoint.

If you have more than four waypoints in FPL 0, you may wish to view flight data for waypoints which are not displayed on the screen. If this is the case, turn on the cursor (**CRSR**) and use the right outer knob to scroll down the flight plan until the waypoint of interest is on the screen.

This display will default to the distance presentation at power-on (figure 4-45). The area in the upper right hand corner of the screen is a cyclic field, which means that . . .

To cycle between distance, ETE, ETA, and desired track on the FPL 0 page:

1. Turn on the cursor (**CRSR**); it will come up over the cyclic field, which in this case is displaying distance (**Dis**) in nautical miles (figure 4-45).

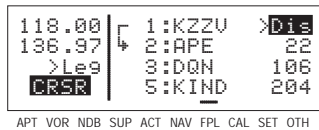

Figure 4-45

2. Press **CLR**. Subsequent presses of the **CLR** button will cycle through **ETE** in hours:minutes (figure 4-46), ETA in terms of the system time zone (figure 4-47), magnetic **Dtk** (figure 4-48), then back to **Dis**.

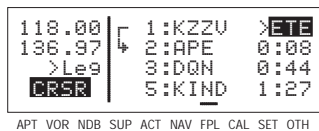

Figure 4-46

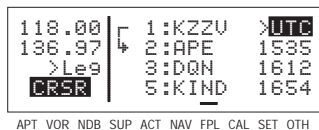

Figure 4-47

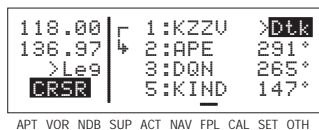

Figure 4-48

Advanced GPS Operation Chapter 4

NOTE: When the cursor is over the cyclic field and it is displaying the ETA time zone, turning the right inner knob changes the system time zone (figure 4-49).

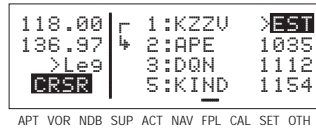

Figure 4-49

NOTE: When the KLX 135A is in OBS mode, the FPL 0 page will present OBS selected course (OBS) as an option instead of magnetic desired track (Dtk). The selected course will be displayed to the right of the active waypoint, and the OBS fields for all other waypoints will be dashed (figure 4-50).

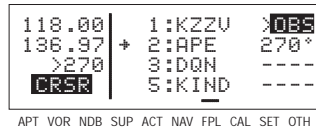

Figure 4-50

4.3. CALCULATOR PAGES

The Calculator (CAL) pages are used for trip planning. They are convenient both on the ground before you begin your flight, and in the air. The CAL 1 page performs distance, bearing, and time calculations, and the CAL 2 page is for advisory fuel planning.

Data entered on any of the Calculator pages has no effect on navigation data provided on any Navigation (NAV) or Flight Plan (FPL) pages. You may perform trip calculations without disturbing ongoing navigation.

NOTE: The Calculator pages rely on pilot enterable inputs for groundspeed, fuel flow, fuel reserve requirements, altitudes, and airspeeds. These pages do not utilize inputs from fuel flow or air data sensors.

4.3.1. THE CALCULATOR 1 (CAL 1) PAGE

The CAL 1 page allows you to do distance, bearing, and time calculations that you might otherwise need a chart, ruler, and pocket calculator for. The KLX 135A will perform these calculations either from waypoint to waypoint (for in-flight calculations, your present position can be one of the waypoints), or for one of your flight plans (active or stored).

To calculate distance, bearing, and time from waypoint to waypoint:

1. From the CAL 1 page (figure 4-51), turn on the cursor (CRSR). It will appear over a cyclic field that either displays **Wpt** (waypoint to waypoint) or **Fpl** (flight plan).

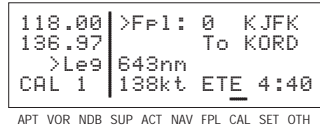

Figure 4-51

2. For this type of calculation, the cyclic field should display **Wpt**. Press **CLR** to toggle if this is not the case (figure 4-52).

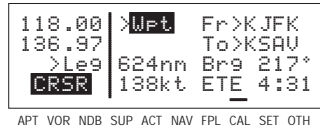

Figure 4-52

3. Turn the right outer knob clockwise to move the cursor to the "from" waypoint in the upper right corner of the screen (figure 4-53).

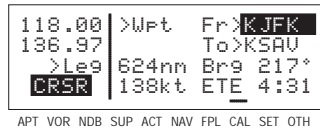

Figure 4-53

4. Enter the desired identifier for the "from" waypoint and press **ENT**. You will be shown the waypoint page for the waypoint you entered. Press **ENT** again to approve.

NOTE: On either of the two waypoint fields on this page, you can select your present position. To do this, press **CLR** while the cursor is on the desired waypoint field. The results will only be displayed when your KLX 135A is receiving a valid position, or if you happen to be in the Take Home mode (see section 4.7).

5. With the cursor over the "to" waypoint, enter the desired identifier (figure 4-54) and press **ENT** twice. The distance in nautical miles and the bearing will be displayed on line 3.

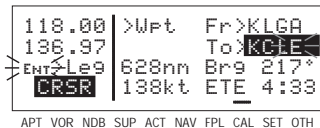

Figure 4-54

6. Use the right outer knob to move the cursor over the groundspeed field on line 4.

7. Select your estimated groundspeed for the trip. As you change it, the estimated time en route (ETE) calculation will be updated (figure 4-55).

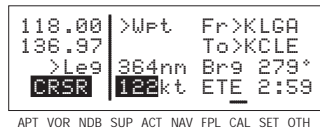

Figure 4-55

To calculate distance and time for a flight plan:

1. From the CAL 1 page, turn on the cursor (**CRSR**). It will appear over a cyclic field that either displays **Wpt** (waypoint to waypoint) or **Fpl** (flight plan).
2. For this type of calculation, the cyclic field should display **Fpl**. Press **CLR** to toggle if this is not the case.
3. Turn the right outer knob clockwise to place the cursor over the flight plan number. As you cycle through the flight plans, the first and last waypoints of each flight plan will be displayed, along with the total distance in nautical miles (figure 4-56).

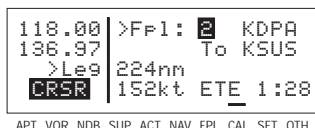

Figure 4-56

4. Once you have selected the desired flight plan, move the cursor to the groundspeed field on line 4.
5. Select your estimated groundspeed for the trip. As you change it, the estimated time en route (ETE) calculation will be updated (figure 4-57).

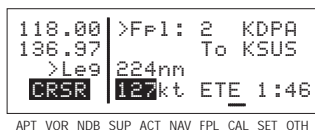

Figure 4-57

4.3.2. THE CALCULATOR 2 (CAL 2) PAGE

The CAL 2 page is for calculating fuel requirements for a trip. To use these pages, you need to have a good idea what the typical fuel flow rate for your aircraft is. This information can often be found for given cruise power settings in a "performance" section of the Pilot's Operating Handbook for the aircraft. The units for fuel are not specified on this page, but the units of time are always hours. This means that you can use gallons per hour, pounds per hour, kilograms per hour, etc. Like with the CAL 1 page, the fuel calculations can be done from waypoint to waypoint (including present position), or for one of your flight plans.

To calculate fuel requirements from waypoint to waypoint:

1. From the CAL 2 page, turn on the cursor (**CRSR**). It will appear over a cyclic field that either displays **Wpt** (waypoint to waypoint) or **Fpl** (flight plan).

2. For this type of calculation, the cyclic field should display **Wpt**. Press **[CLR]** to toggle if this is not the case.

3. Turn the right outer knob clockwise to move the cursor to the "from" waypoint in the upper right corner of the screen (figure 4-58).

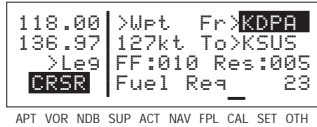

Figure 4-58

4. Enter the desired identifier for the "from" waypoint and press **[ENT]**. The waypoint page for the identifier you just entered will be displayed. If it is the correct one, press **[ENT]** again.

*NOTE: On either of the two waypoint fields on this page, you can select your present position. To do this, press **[CLR]** while the cursor is on the desired waypoint field (figure 4-59). The results will only be displayed when your KLX 135A is receiving a valid position, or if you happen to be in the Take Home mode (see section 4.7, "Using the Take-home Mode").*

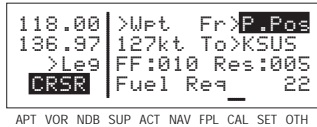

Figure 4-59

5. Move the cursor to the groundspeed field on line 2.

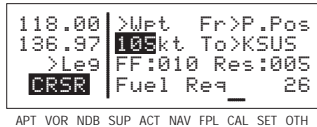

Figure 4-60

6. Select your estimated groundspeed for the trip (figure 4-60).

7. With the cursor over the "to" waypoint, enter the desired identifier (figure 4-61) and press **[ENT]**.

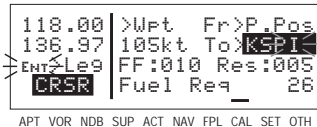

Figure 4-61

8. Move the cursor to the fuel flow rate field and use the right inner knob to select the desired value (figure 4-62). Remember that this can be in any units you desire (as long as it's per hour), but the same fuel units must carry through the calculations.

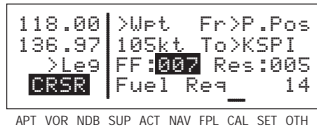

Figure 4-62

- Move the cursor to the fuel reserve requirement field and enter the desired value. As you do, watch the calculation of fuel required on line 4 change (figure 4-63).

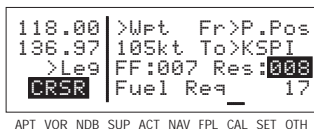

Figure 4-63

To calculate fuel requirements for a flight plan:

- From the CAL 2 page, turn on the cursor (CRSR). It will appear over a cyclic field that either displays **Wpt** (waypoint to waypoint) or **Fpl** (flight plan). Press CLR to toggle if this is not the case.
- For this type of calculation, the cyclic field should display **Fpl**. Press CLR to toggle if this is not the case.

- Turn the right outer knob clockwise to place the cursor over the flight plan number. As you cycle through the flight plans, the first and last waypoints of each flight plan will be displayed (figure 4-64).

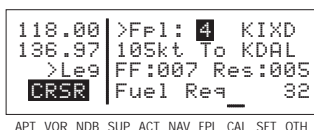

Figure 4-64

- Once you have selected the desired flight plan, move the cursor to the groundspeed field on line 2.
- Select your estimated groundspeed for the trip.
- Move the cursor to the fuel flow rate field and use the right inner knob to select the desired value. Remember that this can be in any units you desire (as long as it's per hour), but the same fuel units must carry through the calculations.

- Move the cursor to the fuel reserve requirement field and enter the desired value. As you do, watch the calculation of fuel required on line 4 change (figure 4-65).

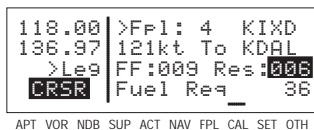

Figure 4-65

4.3.3. THE CALCULATOR 3 (CAL 3) PAGE

The CAL 3 page is used to determine pressure altitude

To calculate the pressure altitude:

- Turn on the cursor (CRSR).

2. Enter the altitude indicated on the aircraft's altimeter (**Ind:**) to the nearest hundred feet by using the right inner knob to select the desired value (figure 4-66).

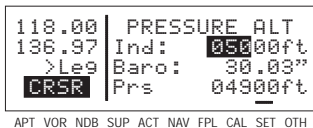

Figure 4-66

3. Use the right outer knob to move the cursor to the **Baro:** field, and then use the right inner knob to enter the current altimeter setting (figure 4-67). The pressure altitude (**Prs**) is now displayed.

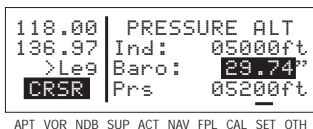

Figure 4-67

NOTE: The altimeter baro set units may be changed between inches, millibars and hectopascals on the SET 8 page (see section 3.15).

4.3.4. THE CALCULATOR 4 (CAL 4) PAGE

The CAL 4 page is used to determine density altitude

To calculate the density altitude:

1. Turn on the cursor (**CRSR**).
2. The pressure altitude (**Prs:**) displayed will be either the last entered pressure altitude on this page, or the last calculated pressure altitude from the CAL 3 page. If you desire to change it, enter the current pressure altitude to the nearest hundred feet by using the right inner knob (figure 4-68).

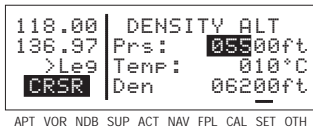

Figure 4-68

3. Use the right outer knob to move the cursor to the first **Temp:** field, and then use the right inner and outer knobs to enter the outside air temperature (degrees Celsius) (figure 4-69). The first digit of the temperature is either "0" if the temperature is above zero or "-" if the temperature is below zero. For maximum accuracy, the static air temperature should be entered. This is the temperature of air without the effect of heating due to the aircraft's movement through the air. For the airspeeds of most piston aircraft, the difference between static air temperature and the observed air temperature (or "total air temperature") is negligible. The density altitude (**Den**) is now displayed.

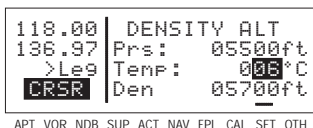

Figure 4-69

4.3.5. THE CALCULATOR 5 (CAL 5) PAGE

The CAL 5 page is used to determine the true airspeed (TAS) of the aircraft.

To calculate the true airspeed (TAS):

- 1 Turn on the cursor (**CRSR**).
2. Enter the aircraft's calibrated airspeed by using the right inner knob (figure 4-70). If the calibrated airspeed isn't known, use the indicated airspeed. For most aircraft the difference between the calibrated airspeed and the indicated airspeed is small at cruise airspeeds.

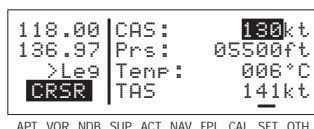

Figure 4-70

3. Use the right outer knob to move the cursor to the **Prs:** field, and then use the right inner knob to enter the aircraft's pressure altitude. If the pressure altitude was previously calculated on the CAL 3 page, or entered on the CAL 4 page, it will already be displayed.
4. Move the cursor to the first **Temp:** position, and then enter the outside air temperature (degrees C) by using the right inner and outer knobs (figure 4-71). The first digit of the temperature is either "0" if the temperature is above zero or "-" if the temperature is below zero. For maximum accuracy, the total air temperature should be entered. This is the temperature of air including the effect of heating due to the aircraft's movement through the air. The temperature read on a standard outside air temperature gauge found on most piston aircraft is "total air temperature". Since the difference between static air temperature and the observed air temperature (or "total air temperature") is usually negligible, any temperature entered on the CAL 4 page is transferred to this page. The true airspeed (TAS) is now displayed.

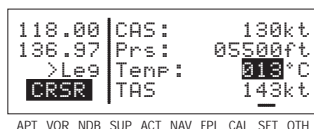

Figure 4-71

4.3.6. THE CALCULATOR 6 (CAL 6) PAGE

The CAL 6 page is used to determine the present wind direction and speed. In addition, the headwind or tailwind component of the wind is displayed.

To calculate the winds aloft:

1. Turn on the cursor (**CRSR**).
2. Enter the aircraft's true airspeed by using the right inner knob (figure 4-72). If the CAL 5 page was previously used to calculate true airspeed, it will already be displayed.
3. Use the right outer knob to move the cursor to the **Hdg:** field, and then use the right inner knob to enter the aircraft's heading (figure 4-73). The headwind or tailwind and the wind direction and speed are now displayed. The wind direction is relative to true North.

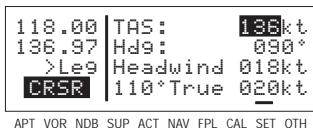

Figure 4-72

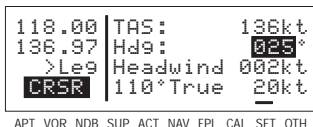

Figure 4-73

NOTE: The wind calculations are only correct when you have entered the correct aircraft heading and true airspeed. Make sure to re-enter new values if you change airspeed or heading.

4.4. CREATING USER-DEFINED WAYPOINTS

You may create and store up to 250 user-defined (also known as supplemental) waypoints. These waypoints will be very helpful to you. One major application is private-use airstrips, which are not included in the Jeppesen data base. They are also handy for points which you fly over frequently, and wish to navigate to. For example, a crop sprayer would want to store the locations of the fields he or she dusts often.

There are three ways to create a user-defined waypoint. If you happen to know the latitude and longitude of the point, that is one option. The waypoint can also be defined as a radial and distance from another waypoint. A third choice is just to store your present position under the identifier you have chosen.

NOTE: Whenever you are in a waypoint entry situation, such as a Direct To waypoint or flight plan, and you enter an identifier which is not in the data base, the KLX 135A will automatically start the user-defined waypoint creation process.

To delete a user-defined waypoint that is no longer needed, see section 3.13.2, "Viewing and Deleting User Waypoints and Waypoint Remarks".

4.4.1. CREATING A WAYPOINT AT YOUR PRESENT POSITION

Creating a waypoint at your present position is the simplest possible way to create a user-defined waypoint. This is nice for "remembering" a spot you are at. Let's suppose you're at a private strip that you want to name "VALLY"

To create a user-defined waypoint at your present position:

1. From any supplemental waypoint (SUP) page, turn on the cursor (**CRSR**). It will flash over the first character in the waypoint identifier field (figure 4-74).

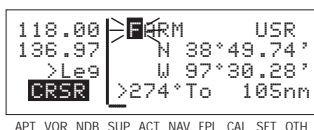

Figure 4-74

2. Use the right inner knob to select the first character of the identifier (figure 4-75). Remember that when the cursor is on, the right inner knob changes the character and the right outer knob moves the cursor around.

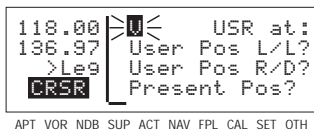

Figure 4-75

3. Spell out the rest of the identifier using the right inner and outer knobs (figure 4-76).

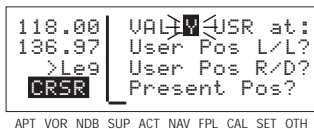

Figure 4-76

4. Move the cursor down to the fourth line, over **Present Pos?** (figure 4-77).

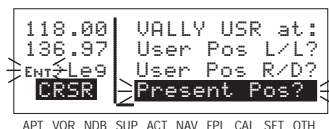

Figure 4-77

5. Press **ENT**. The SUP 1 page for your new waypoint will be displayed with its latitude and longitude (figure 4-78). The cursor is turned off automatically.

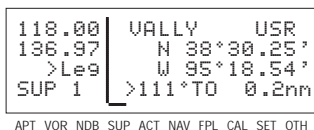

Figure 4-78

4.4.2. CREATING A WAYPOINT AT A CERTAIN LATITUDE/LONGITUDE

It is also possible to create a user-defined waypoint by manually entering a latitude and longitude. Let's say you wanted to create a user waypoint over your farm at N 42°56.32', W 76°29.95'

To create a user-defined waypoint with latitude/longitude:

1. From any supplemental waypoint (SUP) page, turn on the cursor (CURSR). It will flash over the first character in the waypoint identifier field (figure 4-79).
2. Use the right inner knob to select the first character of the identifier (figure 4-80). Remember that when the cursor is on, the right inner knob changes the character and the right outer knob moves the cursor around.
3. Spell out the rest of the identifier using the right inner and outer knobs (figure 4-81).
4. Move the cursor down to the second line, over **User Pos L/L?** (figure 4-82).
5. Press **ENT**. The display will change to a format like figure 4-83.
6. Use the right inner knob to select N for north or S for south (figure 4-84).

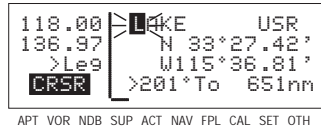

Figure 4-79

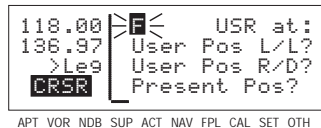

Figure 4-80

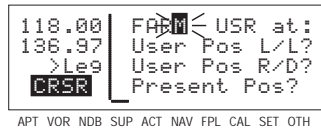

Figure 4-81

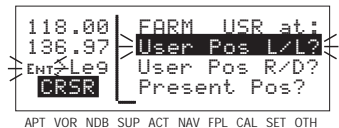

Figure 4-82

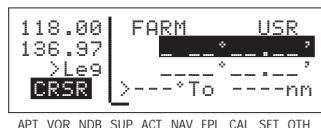

Figure 4-83

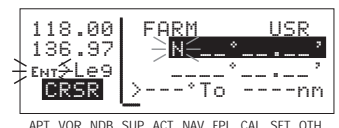

Figure 4-84

- Use the right outer knob to move the cursor, and the right inner knob to select the proper numbers to complete the latitude entry (figure 4-85).

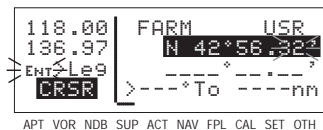

Figure 4-85

- Press **ENT**. The cursor will move to the longitude field.
- Enter the longitude in the same manner as the latitude (figure 4-86).

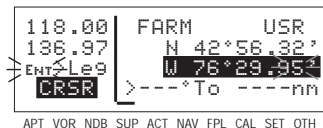

Figure 4-86

- Press **ENT** to approve this position. The cursor will automatically turn off (figure 4-87).

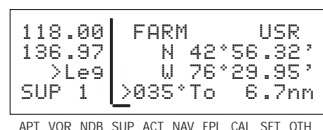

Figure 4-87

4.4.3. CREATING A WAYPOINT REFERENCED FROM ANOTHER WAYPOINT

The third method of creating a user-defined waypoint is as a radial and distance from a known waypoint.

To create a user-defined waypoint using the radial/distance method:

- From any supplemental waypoint (SUP) page, turn on the cursor (**CRSR**). It will flash over the first character in the waypoint identifier field.
- Use the right inner knob to select the first character of the identifier. Remember that when the cursor is on, the right inner knob changes the character and the right outer knob moves the cursor around.

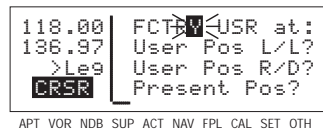

Figure 4-88

- Spell out the rest of the identifier using the right inner and outer knobs (figure 4-88).

- Move the cursor down to the third line, over **User Pos R/D?** (figure 4-89).

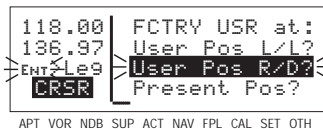

Figure 4-89

5. Press **ENT**. The display will change to a format like figure 4-90 with the cursor over the reference waypoint field.
6. Use the right inner and outer knobs to select the identifier of the desired reference waypoint (figure 4-91).
7. Press **ENT**. The waypoint page for the waypoint you just entered will be displayed (figure 4-92).
8. Press **ENT** again to approve the waypoint. You will be returned to the waypoint creation page.
9. Use the right inner and outer knobs to select the desired radial. Notice that you may enter the angle down to the tenth of a degree (figure 4-93).
10. Press **ENT** to approve the radial. The cursor will move to line 4.
11. Use the right inner and outer knobs to select the desired distance from the reference waypoint (figure 4-94).
12. Press **ENT** to approve the distance. The cursor will automatically be removed from the screen.

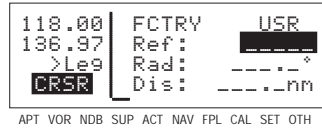

Figure 4-90

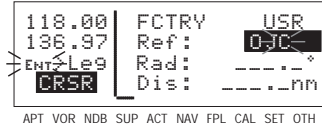

Figure 4-91

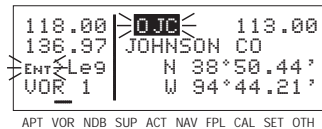

Figure 4-92

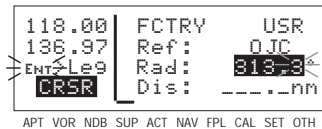

Figure 4-93

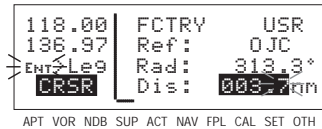

Figure 4-94

4.5. NAVIGATION MODES

The KLX 135A has two modes of operation: En Route-Leg and En Route-OBS. When the KLX 135A is turned on, it always "wakes up" in the En route-Leg mode. The En Route-Leg mode is the normal mode for en route flying. One can think of the OBS mode as similar to VOR navigation, except it allows you to use any waypoint in the same manner as VORs.

The mode is annunciated on the left side of the screen, line 3. When in the En Route-Leg mode, it displays **Leg** (figure 4-95), and when in the En Route-OBS mode, it displays the selected magnetic course (figure 4-96).

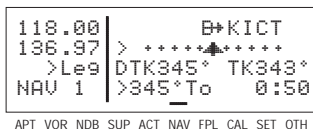

Figure 4-95

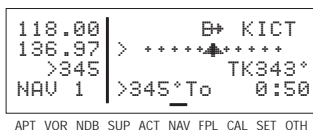

Figure 4-96

4.5.1. SELECTING THE LEG MODE OR THE OBS MODE

To change navigation modes:

1. From any page (except a message page), turn on the cursor (**CRSR**).

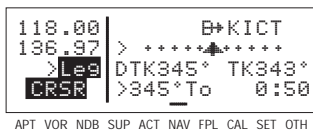

Figure 4-97

2. Turn the right inner knob counter clockwise until the cursor is over the navigation mode. In this case, the current mode is **Leg** (figure 4-97).

3. Press **CLR**. The mode will toggle between Leg and OBS. In the case of OBS mode, the selected course angle will be displayed (figure 4-98).

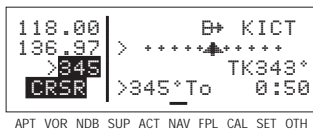

Figure 4-98

4. If you desire to change the selected course while in OBS mode, turn the right inner knob while the cursor is over the mode annunciation (figure 4-99).

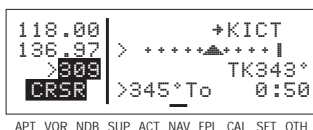

Figure 4-99

5. Turn off the cursor (**CRSR**).

4.5.2. THE EN ROUTE-LEG MODE

The following are the characteristics of the En route-Leg Mode:

1. The course deviation indicator (CDI) sensitivity is plus and minus five nautical miles, full scale. This applies to the CDI on the NAV 1 page as well as any external CDIs or HSI's interfaced to

the KLX 135A. If the CDI or HSI has five dots left and right of the center position, then each dot represents one nautical mile of deviation.

- Navigation is provided along the great circle path between two waypoints. As you probably know, great circle navigation is the shortest distance between two points located on the earth's surface. In the case of Direct To operation, the "from" waypoint is not displayed but it is the point where Direct To operation was initiated. The course to fly while in this mode is referred to as the desired track (Dtk). The desired track is displayed on the NAV 1 page. To fly a great circle course between two points, the desired track may be constantly changing. A good way to illustrate this concept is with a world globe and a piece of string. You can determine the great circle path between Denver, Colorado and Manila, Philippines by stretching the string over the globe between these two points. Notice that you would start the flight with a northwesterly desired track, which gradually becomes due westerly, and finally southwesterly by the time you reach Manila. Of course, your trips with the KLX 135A will be substantially shorter and the desired track will probably change only a few degrees.
- Automatic waypoint sequencing is provided during flight plan operation. As you reach a waypoint in your flight plan, the next leg of the flight plan automatically becomes active.
- Turn anticipation may be utilized in flight plan operation as described in section 4.2.2.

4.5.3. THE EN ROUTE-OBS MODE

The following are characteristics of the En Route-OBS mode.

- (Same as item 1 for En Route-Leg mode) The course deviation indicator (CDI) sensitivity is plus and minus five nautical miles, full scale. This applies to the CDI on the NAV 1 page as well as any external CDIs or HSIs interfaced to the KLX 135A. If the CDI or HSI has five dots left and right of the center position, then each dot represents one nautical mile of deviation.
- The course is defined by the active waypoint and the selected magnetic course. A course "to" or "from" the active waypoint may be selected.
- There is no automatic leg sequencing or turn anticipation.

- When the active waypoint is a VOR, the published magnetic variation for the VOR is utilized rather than the calculated magnetic variation.

4.5.4. EFFECTS OF SWITCHING FROM EN ROUTE-OBS MODE TO EN ROUTE-LEG MODE

The following mode transition occurs if the KLX 135A is in the En Route-OBS mode with a TO indication and the mode is switched to the En Route-Leg mode:

- The waypoint that was active while in the OBS mode remains the active waypoint when the En route-Leg mode is activated. The system does not attempt to orient itself on a leg of the active flight plan.
- The selected course (**Obs**) that was active in the OBS mode prior to switching to Leg mode becomes the desired track (**Dtk**) in the Leg mode.
- With the exception of #2 above, the characteristics of normal Direct To operation apply.
- If the active waypoint was part of the active flight plan (FPL 0), the system will revert to normal flight plan operation once the active waypoint is reached.

If, on the other hand, the KLX 135A is showing a FROM indication when the mode is switched from En Route-OBS to En Route-Leg mode, the system will immediately orient itself on the nearest leg of the flight plan.

4.5.5. ACTIVATING A WAYPOINT WHILE IN THE EN ROUTE-OBS MODE

While in the En route-OBS mode, you may activate another waypoint by using the normal Direct To method or by using a second method. This second method activates another waypoint without changing the selected course (OBS). In other words, when the new waypoint is activated, the D-Bar is not necessarily recentered. In figure 4-100 the KLX 135A is in the En Route-OBS mode and the selected course is 149°. You have just crossed ARG and desire to activate the next waypoint in the flight plan, GQE, without recentering the D-Bar.

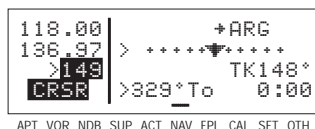

Figure 4-100

To activate a waypoint in OBS mode without changing the selected course:

1. Press **[D→]** (figure 4-101). The rules described in section 4.9, "Direct To Operation", dictate which waypoint identifier will be initially displayed on the Direct To page. Change the waypoint if necessary.

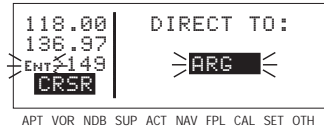

Figure 4-101

2. Press **[D→]** a second time. The annunciation **DIRECT TO** changes to **ACTIVATE** (figure 4-102). Repeated presses of **[D→]** cause the annunciation to alternate between **DIRECT TO** and **ACTIVATE**. Make sure **ACTIVATE** is displayed.

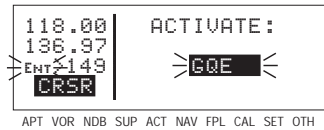

Figure 4-102

3. If the desired waypoint is not the one that was suggested by the KLX 135A, enter the desired identifier. Press **[ENT]**.
4. Press **[ENT]** to approve the waypoint page and activate the waypoint (figure 4-103). The selected course does not change, therefore this method does not center the D-Bar like a Direct To operation does.

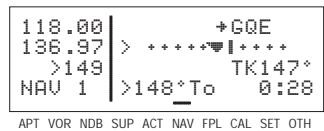

Figure 4-103

4.6. OPERATION OUTSIDE THE PRIMARY COVERAGE AREA

The KLX 135A's primary coverage area is from N 74° to S 60° as was shown in figure 4-1. Navigation outside this area is automatically referenced to true North unless a manual input of magnetic variation is made on the SET 2 page. The same is true anytime the KLX 135A is in the OBS mode and the active waypoint is outside the primary coverage area. Under both of these conditions, the following message will be displayed on the Message page:

***Magnetic Var Invalid
All Data Referenced
To True North**

When navigation is within the primary coverage area, the SET 2 page does not display magnetic variation (figure 4-104). However, under the conditions stated above, a user magnetic variation may be entered on line 4 of the SET 2 page.

118.00	DATE/TIME
136.97	25 DEC 94
>Leg	1830:09 EST
SET 2	Eastern Std

APT VOR NDB SUP ACT NAV FPL CAL SET OTH

Figure 4-104

To enter the local magnetic variation manually on the SET 2 page:

1. Turn on the cursor (**CRSR**).
2. Move the cursor over the numerical field on line 4 (figure 4-105).
3. Use the right knobs to select the magnetic variation, from 0 to 99 degrees.
4. Move the flashing part of the cursor to the E/W (east/west) field and select whether the magnetic variation is easterly or westerly (figure 4-106).

118.00	DATE/TIME
136.97	25 DEC 94
>Leg	1830:09 EST
CRSR	Mag Var: <u>10</u> °E

APT VOR NDB SUP ACT NAV FPL CAL SET OTH

Figure 4-105

118.00	DATE/TIME
136.97	25 DEC 94
>Leg	1830:09 EST
CRSR	Mag Var: <u>21</u> °E

APT VOR NDB SUP ACT NAV FPL CAL SET OTH

Figure 4-106

5. Press **ENT** to approve and turn the cursor (**CRSR**) off.

4.7. USING THE TAKE-HOME MODE

It is very likely that the KLX 135A will become your "best friend" in the cockpit, especially in VFR flight. As with any good friend, you may need some time to get well-acquainted. This will allow you to utilize it to the maximum extent. A great way to get to know the KLX 135A is to use it outside the airplane, using what we call the "take-home mode".

There are products available which allow you to use the KLX 135A at your home, office, or hotel to have get-acquainted time in the take-home mode, for instance the Commander 2000 from Lone Star Aviation. It is also helpful to do flight planning and perform data base updates outside the airplane, perhaps with a home personal computer.

For more information on the Commander 2000, or to place an order, contact:

Lone Star Aviation Corp.
1306 Tatum Drive
Arlington, TX 76012
Phone: (817) 548-7768
FAX: (817) 261-8692

When the KLX 135A is in the take-home mode, it performs as if it is receiving adequate satellite signals to determine its position. It displays the latitude and longitude of its last known position or of whatever position it is initialized to on the Setup 1 (SET 1) page (see section 3.6, "Initialization and Time to First Fix"). In addition, a ground speed and heading may be entered on the SET 1 page and the KLX 135A will track a flight plan or a direct to waypoint just as if it was actually functioning in an aircraft. Distances count down, waypoints sequence, and the deviation bar follows the progress of the simulated flight. Using the take-home mode is an excellent way to learn the operation of the KLX 135A without worrying about the engine running, other traffic, or even terrain (fortunately, these phenomena are not simulated in the take-home mode!

This page intentionally left blank

5. COMM OPERATION

This section describes the use of the VHF Communication Transceiver portion of the KLX 135A. If you are not yet familiar with the procedure of turning on and initializing the KLX 135A, see section 3.2, "Turn-on and Self Test".

5.1. ENTERING FREQUENCIES

5.1.1. FREQUENCY SELECTION

The KLX 135A is capable of tuning VHF communication frequencies from 118.000 MHz (megahertz) to 136.975 MHz.

To tune a COMM frequency:

1. Use the left outer knob to select the desired number of megahertz between 118 and 136. In figure 5-1, the frequency 122.90 MHz is desired.
2. Make sure the left inner knob is pushed in, and use it to complete the desired frequency. In this case, the left inner knob changes the frequency in increments of 0.05 MHz (50 kHz) (figure 5-2). Note that the left inner knob must be rotated three clicks clockwise to go from 122.75 MHz to 122.90 MHz.

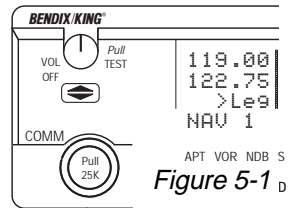

Figure 5-1

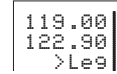



Figure 5-2

5.1.2. STANDBY FREQUENCY ENTRY

The default frequency entry mode is standby frequency entry. In the standby frequency entry mode, both the active and standby communication frequencies are displayed, and any frequency tuning is performed on the standby frequency.

To tune a COMM frequency using the standby frequency entry mode:

1. Use the left knobs to tune the standby COMM frequency, such as 122.90 MHz (figure 5-2 above).
2. To exchange the active and standby frequencies, press the  (flip-flop) button (figure 5-3).

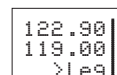

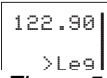



Figure 5-3

5.1.3. ACTIVE FREQUENCY ENTRY

You can also tune the KLX 135A active frequency directly.

To tune a COMM frequency using the active frequency entry mode:

1. Press and hold the  button for approximately 2 seconds. The standby frequency will disappear and the active frequency will be the same as before you pressed the  button (figure 5-4).  *Figure 5-4*
2. You can now use the left knobs to tune the active COMM frequency.
3. To change back to standby frequency entry mode, press the  button momentarily.

5.1.4. 25 KILOHERTZ CHANNEL SPACING OPERATION

Some communication frequencies are multiples of 25 kilohertz (for example 125.975 MHz). KLX 135A allows you to easily tune these frequencies.

To tune a 25 kHz COMM frequency:

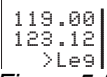
1. Pull the left inner knob out.
2. Use the left knobs to tune the frequency. Notice that the KLX 135A only displays two digits after the decimal point, so it has to cut off the last digit. For example, in figure 5-5 the standby frequency is 123.125 MHz and the KLX 135A displays 123.12.  *Figure 5-5*
3. When you're ready to go back to 50 kHz tuning, push the left inner knob back in. This will allow you to select frequencies with fewer turns of the knob.

5.1.5. USING QuickTune™ FREQUENCY SELECTION

The KLX 135A gives you the ability to look up an airport VHF communication frequency from the navigation data base and load it directly into to COMM transceiver. That way, you don't have the risk of getting the wrong frequency or making a tuning error. The QuickTune™ function is accessible on the Airport 4 (APT 4) page. You may also use the Active 4 (ACT 4) page, if the active waypoint is an airport (see section 4.2.3).

To tune a COMM frequency from the data base:

1. Use the right outer and inner knobs to locate the APT 4 (or ACT 4, if the active waypoint is an airport) page for the facility you desire to communicate with (figure 5-6). The APT 4 page displays the frequency type (TWR = Tower Frequency, GRND = Ground Control, PCL = Pilot-controlled Lighting, etc.) and frequency.

119.00	KCOU		
121.60	ATIS*	128.45	
>Le9	GRND*	121.60	
APT+4	TWR *	119.30	

APT VOR NDB SUP ACT NAV FPL CAL SET OTH

Figure 5-6

2. Press the **CRSR** button to turn the cursor on and use the right outer knob to scan through all the airport's frequencies (figure 5-7). There may be more frequencies than can be displayed at one time.

119.00	KCOU		
121.60	CTR *	118.40	
>Le9	CTAF*	119.30	
CRSR	PCL *	119.30	

APT VOR NDB SUP ACT NAV FPL CAL SET OTH

Figure 5-7

3. When you have the cursor over the desired frequency, press **ENT** and that frequency will become the standby frequency in the COMM transceiver (figure 5-8). The cursor turns off automatically.

119.00	KCOU		
119.30	CTR *	118.40	
>Le9	CTAF*	119.30	
APT+4	PCL *	119.30	

APT VOR NDB SUP ACT NAV FPL CAL SET OTH

Figure 5-8

NOTE: QuickTune™ frequency selection may also be used to select nearest Flight Service Station and ARTCC/FIR frequencies in the same way. To access these pages, press the **MSG** and **ENT** buttons, then select the **FSS?** or **CTR?** option, as desired.

5.2. RECEIVE/TRANSMIT ANNUNCIATION

The KLX 135A display tells you when it is receiving and transmitting! When you key the mic and the KLX 135A COMM transmits, a small “T” is displayed above the active frequency (figure 5-9).

One instance where this is nice is if you have multiple COMM transmitters in the aircraft, it tells you when you are transmitting on the KLX 135A. Whenever the KLX 135A’s receiver breaks the squelch, an “R” is displayed in the same spot (figure 5-10). If the volume happens to be turned down low on the KLX 135A, your audio panel, or your headphones, you may not hear the audio, but you **will see** the “R” annunciation. Note that you can’t receive and transmit at the same time.

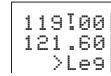

Figure 5-9

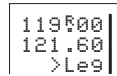

Figure 5-10

5.3. VOLUME ADJUSTMENT AND AUTOMATIC SQUELCH OVERRIDE

The small knob in the upper left corner of the KLX 135A is not only the ON/OFF switch, it is used to adjust the COMM audio volume. By pulling this knob out you can override the automatic squelch, either to receive a distant, weak signal or to give you a noise reference to adjust the volume by.

5.4. STUCK MICROPHONE PROTECTION

Occasionally, a microphone switch can get stuck in the “on” position. When this happens, you can jam the frequency. To prevent this, the KLX 135A automatically shuts down the transmitter whenever it is keyed for more than 35 seconds at a time. When this happens, the COMM frequency display area is replaced with a flashing **Stuck Mic** message (figure 5-11) until the microphone key is turned off.

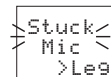



Figure 5-11

When this is the case, tuning the COMM with the left knobs or pressing the flip-flop button will cause the words **Stuck Mic** to be removed, allowing you to see what you are tuning. This is helpful if you desire to listen to a different frequency than you were when the microphone got stuck. Five seconds after you stop adjusting the frequency in any way, the **Stuck Mic** message will reappear.

If you are intentionally making a lengthy transmission and **Stuck Mic** is displayed, simply release the microphone key for an instant and then resume your transmission.

5.5 BLIND TUNING FEATURE

Turning the unit on while holding the flip-flop () button will bring the KLX 135A up in the active frequency entry mode, automatically loading 120.00 MHz into the active COMM frequency (figure 5-12). This allows the pilot to “blind-tune” the radio in the event of a display failure.

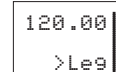



120.00
>Leg

Figure 5-12

The COMM standby frequency will also be 120.00 MHz, although it is not displayed during active entry.

To accurately tune the active frequency on the COMM, count up 1 MHz for each clockwise click of the left outer knob, and down 1 MHz for each counterclockwise click of the knob. Similarly, count up or down 50 kHz or 25 kHz per click of the left inner knob, depending on whether it is pushed in or pulled out, respectively.

IMPORTANT NOTE: *In order to have the ability to change the COMM frequency, the pages of the turn-on sequence (Self-Test, Initialization, VFR, and Data Base) must be approved. Hold the  button down for about two seconds after applying power to the KLX 135A. Then, wait about 20 seconds and press the  button four times to approve these pages.*

This page intentionally left blank

APPENDIX A - NAVIGATION TERMS

- BRG - Bearing to waypoint (degrees)
- DA - Drift Angle (degrees)
- DIS - Distance to waypoint (nm)
- DTK - Desired Track (degrees)
- OBS - Selected Course
- GS - Groundspeed (nm/hr)
- HDG - Heading (degrees)
- POS - Present position
- TK - Actual Track (degrees)
- WPT - Waypoint
- XTK - Cross Track Error Correction (nm)
displayed as "FLY L 2.3 nm"
- ETE - Estimated Time Enroute (hrs:min)
- ETA - Estimated Time of Arrival

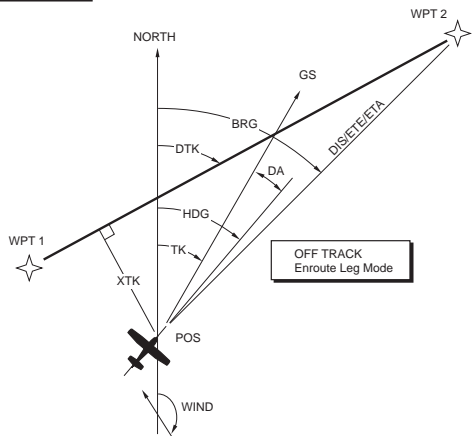
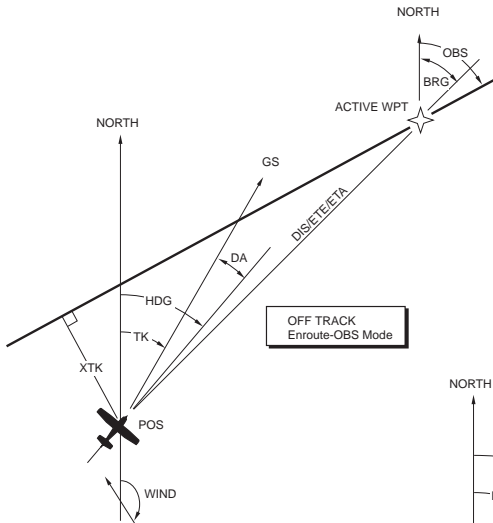
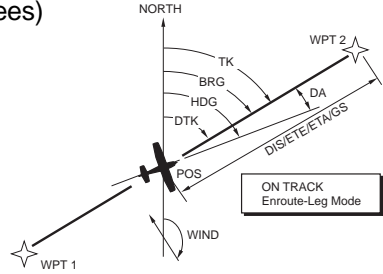

This page intentionally left blank

APPENDIX B - MESSAGE PAGE MESSAGES

Adj Nav Crs to 234° — (Adjust navigation indicator course to 234°)
When this message appears, you should select the suggested course on the HSI or CDI. When the KLX 135A is in the En Route-Leg mode, this message occurs at the beginning of turn anticipation (prior to reaching the active waypoint) if the upcoming course change is greater than 5°. See section 4.2.2.

Airspace Alert

[name and type of special use airspace]

[altitude boundaries]

[responsible ATC facility] -- This message appears when the estimated time to enter a special use airspace (SUA) is approximately 10 minutes or when the distance from an area of special use airspace is less than two nautical miles. See section 3.15.

All Wpt Remarks Used, Delete on OTH 4 Page — This message will be displayed if you attempt to enter a waypoint remark and the user database already contains 100 waypoint remarks.

Altitude Fail — This message will be displayed if the altitude input becomes invalid during operation.

Battery Low: Service Required to Prevent User Data Loss — This message will be displayed when the KLX 135A's internal battery is low and needs replacing at an authorized AlliedSignal service center. The battery should be replaced within a week to prevent the loss of all user-defined data including waypoints, airport remarks, flight plans, etc. Typical battery life is approximately three to five years.

Check Real Time Clock -- This message appears when a possible fault is detected with the KLN 35A's internal real time clock. This condition does not require immediate service. Manually initialize the time on the Initialization Page to minimize the time to first fix (see section 3.6).

COMM System Failed, Service Required — This message appears if the communication transceiver is unable to function. Service from an authorized AlliedSignal service center is required.

Data Base Error: Publ Data Not Useable, Service Required — This message appears if the data base fails an internal test when the KLX 135A is turned on.

Data Base Outdated, All Data Must be Confirmed Before Use —

This message appears when the data base is out of date as a result of a date and time entered on the SET 2 page or Self-Test page or as a result of a pilot-entered date being overridden by a date from the GPS receiver.

Inside SUA

[name and type of special use airspace]

[altitude boundaries]

[responsible ATC facility] -- (Inside Special Use Airspace) This message appears when the aircraft is inside special use airspace (SUA). See section 3.15.

Magnetic Var Invalid All Data Referenced To True North — This message appears when the magnetic variation is invalid due to operation outside of the data base magnetic variation area without having a pilot-entered magnetic variation. See section 4.6.

No GPS Receiver Data — This message appears when the KLX 135A fails a specific internal test for the GPS receiver. This failure will prevent the unit from providing any navigation capability.

OBS Waypoint > 200nm — (OBS mode waypoint greater than 200 nm away) This message is displayed when the KLX 135A is in the OBS mode and the distance to the active waypoint is more than 200 nautical miles.

Other WPTs Deleted — (Other waypoints deleted) This message is displayed whenever more than 10 waypoints used in a flight plan (including the active waypoint) have been deleted.

Position of _____ has Changed -- This message appears when either the latitude or the longitude of a waypoint used in a flight plan or the active waypoint has changed by more than .33 minutes as a result of updating the data base.

Positions of Other WPTs Have Changed -- This message appears when the above message "Position of _____ has Changed" would be effective for more than ten waypoints..

RCVR HW Error: ____ -- (Receiver Hardware Error) This message appears when the KLX 135A fails a specific internal test for the GPS receiver. The blank will contain a numerical value which may provide assistance to maintenance personnel.

Recycle Power to Use Valid Data Base Data -- This message appears when the date entered on the Initialization page is before the data base effective date and the date entered later on the SET 2 page is after the data base effective date, or vice versa. Turn the KLX 135A off and back on so that the correct data base data is utilized.

User Data Base Lost -- This message appears when the KLN 89(B) determines that the internal memory backup battery is dead or that some other internal failure has occurred which has caused user-entered waypoints, flight plans, and waypoint remarks to be lost.

User Data Lost -- This message appears when the KLN 89 determines that the internal memory backup battery is dead or that some other internal failure has occurred which has caused user data such as page setups to be lost.

WPT _____ Deleted -- This message appears when a waypoint used in a flight plan, or the active waypoint, no longer exists as a result of updating the data base. The blank space is filled in with the waypoint identifier. The waypoint is deleted from flight plans in which it was used.

This page intentionally left blank

APPENDIX C - SCRATCHPAD MESSAGES

Scratchpad messages are temporarily displayed in reverse video in the bottom left corner of the screen. The following are scratchpad messages that may appear:

Active Wpt — (Active Waypoint) Appears when you attempt to delete a user-defined waypoint on the OTH 3 page if the waypoint is the active waypoint (the waypoint you are navigating to). Another waypoint must be made the active waypoint before this waypoint can be deleted from the user-defined waypoint list.

Dup Ident — (Duplicate Identifier) Appears when you select a waypoint identifier on one of the waypoint type pages if there is more than one waypoint of that waypoint type having the same identifier.

Invalid Ent — (Invalid Entry) Appears when you attempt to enter data which is not a valid entry such as trying to enter a date of 30 FEB 95.

Invalid Freq — (Invalid Frequency) Appears when you attempt to transfer a frequency outside the VHF communication band (i.e. in the VOR band) from an APT 4, FSS, or CTR page.

No Act Wpt — (No Active Waypoint) Appears when you attempt to activate the OBS mode if there is no active waypoint. To have an active waypoint, a flight plan must be activated of a Direct To must be initiated.

NoSuch Wpt — (No Such Waypoint) Appears when there is no waypoint in the data base corresponding to the entered identifier on the Supplemental Waypoint page.

Remrks Full — (Remarks Full) Appears when you attempt to create a user-entered Airport or Supplemental Waypoint remark on the APT 5 or SUP 3 page if 100 user-entered remarks already exist. In order to create additional airport remarks, some existing remarks must be deleted on the OTH 4 page.

Used In Fpl — (Used in Flight Plan) Appears when you attempt to delete a user-defined waypoint on the OTH 3 page if the waypoint is used in a flight plan. Either this waypoint must be deleted from the flight plan or the entire flight plan must be deleted before this waypoint can be deleted from the user-defined waypoint list.

USR DB Full — (User Data Base Full) Appears when you attempt to create a user-defined waypoint if the user data base already contains 250 waypoints. In order to create additional user-defined waypoints, it will first be necessary to delete existing user-defined waypoints on the OTH 3 page.

This page intentionally left blank

APPENDIX D - ABBREVIATIONS**STATE ABBREVIATIONS**

<u>ABBREVIATION</u>	<u>STATE</u>
AK	Alaska
AL	Alabama
AR	Arkansas
AZ	Arizona
CA	California
CO	Colorado
CT	Connecticut
DC	District of Columbia
DE	Delaware
FL	Florida
GA	Georgia
IA	Iowa
ID	Idaho
IL	Illinois
IN	Indiana
KS	Kansas
KY	Kentucky
LA	Louisiana
MA	Massachusetts
MD	Maryland
ME	Maine
MI	Michigan
MN	Minnesota
MO	Missouri
MS	Mississippi
MT	Montana
NC	North Carolina
ND	North Dakota
NE	Nebraska
NH	New Hampshire
NJ	New Jersey
NM	New Mexico
NV	Nevada
NY	New York
OH	Ohio
OK	Oklahoma

STATE ABBREVIATIONS (Cont'd)

OR	Oregon
PA	Pennsylvania
RI	Rhode Island
SC	South Carolina
SD	South Dakota
TN	Tennessee
TX	Texas
UT	Utah
VA	Virginia
VT	Vermont
WA	Washington
WI	Wisconsin
WV	West Virginia
WY	Wyoming

CANADIAN PROVINCE ABBREVIATIONS

<u>ABBREVIATION</u>	<u>PROVINCE</u>
AB	Alberta
BC	British Columbia
MB	Manitoba
NB	New Brunswick
NF	Newfoundland
NS	Nova Scotia
NW	Northwest Territory
ON	Ontario
PE	Prince Edward Island
PQ	Quebec
SK	Saskatchewan
YK	Yukon

COUNTRY ABBREVIATIONS

<u>ABBREVIATION</u>	<u>COUNTRY</u>
AFG	Afghanistan
AGO	Angola
AIA	Anguilla Isl.
ALB	Albania
ANT	Antarctica/Netherlands Antilles/Aruba

COUNTRY ABBREVIATIONS (Cont'd)

ARE	United Arab Emirates
ARG	Argentina
ASM	American/Western Samoa
ATG	Antigua/Barbuda
AUS	Australia
AUT	Austria
BDI	Burundi
BEL	Belgium
BEN	Benin
BFA	Burkina Faso
BGD	Bangladesh
BGR	Bulgaria
BHR	Bahrain
BHS	Bahamas
BHU	Bhutan
BLZ	Belize
BMU	Bermuda
BOL	Bolivia
BRA	Brazil
BRB	Barbados
BRN	Brunei
BWA	Botswana
CAF	Central African Republic
CHE	Switzerland
CHL	Chile/Easter Isl.
CHN	China
CIV	Ivory Coast
CMR	Cameroon
CNR	Canary Islands
COG	Congo
COK	Cook Islands
COL	Colombia/San Andres
CRI	Costa Rica
CSK	Czechoslovakia
CUB	Cuba
CYM	Cayman Islands
CYP	Cypress
DEU	Germany
DJI	Djibouti
DMA	Dominica

COUNTRY ABBREVIATIONS (Cont'd)

DNK	Denmark
DOM	Dominican Republic
DZA	Algeria
ECU	Ecuador
EGY	Egypt
ERI	Eritrea
ESP	Spain
ETH	Ethiopia
FIN	Finland
FJI	Fiji/Tonga
FLK	Falkland Islands
FRA	France
GAB	Gabon
GBR	United Kingdom
GHA	Ghana
GIB	Gibraltar
GIN	Guinea
GLP	Guadeloupe/Martinique
GMB	Gambia
GNB	Guinea-Bissau
GNQ	Equatorial Guinea
GPV	Cape Verde
GRC	Greece
GRD	Grenada
GRL	Greenland
GTM	Guatemala
GUF	French Guiana
GUY	Guyana
HKG	Hong Kong
HND	Honduras
HTI	Haiti
HUN	Hungary
IDN	Indonesia
IND	India
IOT	British Indian Ocean Territory
IRL	Ireland
IRN	Iran
IRQ	Iraq
ISL	Iceland
ISR	Israel

COUNTRY ABBREVIATIONS (Cont'd)

ITA	Italy
JAM	Jamaica
JOR	Jordan
JPN	Japan/Okinawa
JTN	Johnston Island
KEN	Kenya
KHM	Cambodia/Kampuchea
KIR	Kiribati/Tuvalu/Phoenix I./Line I.
KNA	St. Kitts/Nevis
KOR	Korea
KWT	Kuwait
LAO	Laos
LBN	Lebanon
LBR	Liberia
LBY	Libya/SPA Jamahiriya
LCA	St. Lucia
LKA	Sri Lanka
LSO	Lesotho
LUX	Luxembourg
MAC	Macau
MAR	Morocco
MDG	Madagascar/Comoros/Mayotte I./Reunion
MDV	Maldives
MEL	Melilla
MEX	Mexico
MHL	Marshall Island
MID	Midway Island
MLI	Mali
MLT	Malta
MNP	Mariana Islands
MOZ	Mozambique
MRT	Mauritania
MSR	Montserrat Isl.
MUS	Mauritius
MWI	Malawi
MYR	Myanmar
MYS	Malaysia
NCL	New Caledonia
NER	Niger
NGA	Nigeria

COUNTRY ABBREVIATIONS (Cont'd)

NIC	Nicaragua
NIU	Niue Island
NLD	Netherlands
NOR	Norway
NPL	Nepal
NRU	Naura
NZL	New Zealand
OMN	Oman
PAC	Oakland OTCA (PACIFIC)
PAK	Pakistan
PAN	Panama
PCI	Caroline Island/Micronesia
PER	Peru
PHL	Philippines
PNG	Papua New Guinea
POL	Poland
PRI	Puerto Rico
PRK	Korea (Dem. Peoples Republic)
PRT	Portugal/Azores/Madeira Isl.
PRY	Paraguay
PYF	French Polynesia/Society Isl./Tuamotu
QAT	Qatar
ROM	Romania
RWA	Rwanda
SAU	Saudi Arabia
SDN	Sudan
SEN	Senegal
SGP	Singapore
SHN	Ascension Island/St. Helena
SLB	Solomon Islands
SLE	Sierra Leone
SLV	El Salvador
SOM	Somalia
SPM	St. Pierre/Miquelon
STP	Sao Tome/Principe
SUR	Suriname
SVK	Slovakia
SWE	Sweden
SWZ	Swaziland
SYC	Seychelles

COUNTRY ABBREVIATIONS (Cont'd)

SYR	Syria
TCA	Turks and Caicos Islands
TCD	Chad
TGO	Togo
THA	Thailand
TTO	Trinidad/Tobago (SP?)
TUN	Tunisia
TUR	Turkey
TWN	Taiwan
TZA	Tanzania
UGA	Uganda
URY	Uruguay
USA	Baker Islands
VCT	St. Vincent
VEN	Venezuela
VGB	Virgin Islands (U.K.)
VIR	Virgin Islands (U.S.)
VNM	Vietnam
VUT	Vanautu
WAK	Wake Island
WLF	Wallis/Futuna Islands
XJ1	Kazakhstan/Kyrgyzstan
XJ2	Armenia/Georgia
XJ3	Ukraine/Moldova
XJ4	Estonia/Russia
XJ5	Belarus/Latvia/Lithuania/Russia
XJ6	Kazakhstan/Russia
XJ7	Kazakhstan/Tajikistan/Turkmenistan/ Uzbekistan
XJJ	Azerbaijan
XJR	Russia
YEM	Yemen (Arab Republic)
YUG	Yugoslavia
ZAF	South Africa
ZAM	Zambia
ZAR	Zaire
ZWE	Zimbabwe

ARTCC ABBREVIATIONS

<u>ABBREVIATION</u>	<u>ARTCC</u>
ABQ	ALBUQUERQUE
ACC	ACCRA
ADD	ADDIS ABABA
ADE	ADELAIDE
ADN	ADEN
AKM	AKMOLA
AKT	AKTYUBINSK
ALG	ALGIERS
ALM	ALMATY
AMD	AMDERMA
AMM	AMMAN
AMS	AMSTERDAM
ANA	ANADYR
ANC	ANCHORAGE ARCTIC
ANC	ANCHORAGE
ANC	ANCHORAGE OCEANIC
ANK	ANKARA
ANT	ANTANANARIVO
ARK	ARKHANGELSK
ASH	ASHKHABAD
ASM	ASMARA
AST	ASTRAKHAN
ASU	ASUNCION
ATF	ANTOFAGASTA
ATH	ATHENS
ATL	ATLANTA
ATY	ATYRAU
AUC	AUCKLAND OCEANIC
AUC	AUKLAND
BAG	BAGHDAD
BAH	BAHRAIN
BAK	BAKU
BAL	BALI
BAN	BANGKOK
BAR	BARCELONA
BAT	BATAGAY
BEI	BEIJING
BEL	BELEM
BER	BERMUDA
BIA	BIAK

ARTCC ABBREVIATIONS (Cont'd)

BIS	BISHKEK
BLA	BLAGOVESHCHENSK
BLG	BELGRADE
BLO	BLOEMFONTEIN
BOD	BODO
BOD	BODO OCEANIC
BOG	BOGOTA
BOM	BOMBAY
BOR	BORDEAUX
BOS	BOSTON
BRA	BEIRA
BRD	BRINDISI
BRE	BREMEN
BRI	BRISBANE
BRL	BERLIN
BRN	BARNAUL
BRR	BARRANQUILLA
BRS	BRASILIA /UTA
BRT	BEIRUT
BRU	BRUSSELS
BRV	BRATISLAVA
BRY	BERYOZOVO
BRZ	BRAZZAVILLE
BSK	BRATSK
BST	BREST
BUC	BUCHAREST
BUD	BUDAPEST
BUJ	BUJUMBURA
CAI	CAIRO
CAL	CALCUTTA
CAM	CAMPO GRANDE
CAM	CENTRAL AMERICA
CAN	CANARIES
CAP	CAPE TOWN
CAS	CASABLANCA
CHA	CHAYBUKHA
CHE	CHELYABINSK
CHI	CHICAGO
CHO	CHOKURDAKH
CHR	CHERSKY
CHT	CHITA

ARTCC ABBREVIATIONS (Cont'd)

CHU	CHULMAN
CLE	CLEVELAND
COC	COCOS I
COL	COLOMBO
COP	COPENHAGEN
COR	CORDOBA
CRT	CURITIBA
CUR	CURACAO
DAK	DAKAR
DAK	DAKAR OCEANIC
DAM	DAMASCUS
DAR	DARWIN
DEL	DELHI
DEN	DENVER
DES	DAR-ES-SALAAM
DHA	DHAKA
DIK	DIKSON
DOR	DORNOD
DSS	DUSSELDORF
DUR	DURBAN
DUS	DUSHANBE
EDM	EDMONTON
EMI	EMIRATES
ENT	ENTEBBE
EZE	EZEIZA
FRA	FRANKFURT
FW	FT WORTH
GAB	GABORONE
GAN	GANDER DOMESTIC
GAN	GANDER OCEANIC
GEN	GENEVA
GEO	GEORGETOWN
GUA	GUANGZHOU
GUY	GUAYAQUIL
HAN	HANOI
HAR	HARARE
HAV	HAVANA
HK	HONG KONG
HNR	HONIARA
HOC	HOCHIMINH

ARTCC ABBREVIATIONS (Cont'd)

HON	HONOLULU CERAP
HOU	HOUSTON
HOU	HOUSTON OCEANIC
IND	INDIANAPOLIS
IRK	IRKUTSK
ISL	ISLA DE PASCUA
IST	ISTANBUL
JAK	JAKARTA
JAX	JACKSONVILLE
JED	JEDDAH
JOH	JOHANNESBURG
KAB	KABUL
KAL	KALININGRAD
KAM	KAMENNYI MYS
KAN	KANO
KAR	KARACHI
KAT	KATHMANDU
KAZ	KAZAN
KC	KANSAS CITY
KHA	KHABAROVSK
KHR	KHARKOV
KHT	KHATANGA
KIE	KIEV
KIG	KIGALI
KIN	KINGSTON
KIR	KIRENSK
KIS	KISANGANI
KK	KOTA KINABALU
KL	KUALA LUMPUR
KM	KHANTY-MANSIYSK
KNS	KINSHASA
KO	KZYL-ORDA
KOL	KOLPASHEVO
KOS	KOSTANAY
KRA	KRASNOVODSK
KRS	KRASNOYARSK
KRV	KIROV
KSH	KISHINAU
KTM	KHARTOUM
KUN	KUNMING

ARTCC ABBREVIATIONS (Cont'd)

KUR	KURGAN
LAH	LAHORE
LAN	LANZHOU
LAP	LA PAZ
LAX	LOS ANGELES
LIL	LILONGWE
LIM	LIMA
LIS	LISBON
LJU	LJUBLJANA
LON	LONDON
LUA	LUANDA
LUB	LUBUMBASHI
LUS	LUSAKA
LVO	LVOV
MAD	MADRID
MAG	MAGADAN
MAI	MAIQUETIA
MAL	MALE
MAN	MANILA
MAR	MARSEILLE
MAU	MAURITIUS
MAZ	MAZATLAN
MAZ	MAZATLAN OCEANIC
MDR	MADRAS
MEL	MELBOURNE
MEM	MEMPHIS
MEN	MENDOZA
MER	MERIDA
MEX	MEXICO
MGD	MAGDAGACHI
MIA	MIAMI
MIA	MIAMI OCEANIC
MIL	MILAN
MIN	MINNEAPOLIS
MIR	MIRNY
MLM	MALMO
MLT	MALTA
MNC	MONCTON NORTHERN
MNC	MONCTON SOUTHERN
MNS	MANAUS

ARTCC ABBREVIATIONS (Cont'd)

MNT	MONTERREY
MOG	MOGADISHU
MON	MONTREAL
MOS	MOSCOW
MRM	MURMANSK
MS	MYS SHMIDTA
MSK	MINSK
MTV	MONTEVIDEO
MUN	MUNICH
MUR	MUREN
MUS	MUSCAT
NAD	NADI OCEANIC
NAH	NAHA
NAI	NAIROBI
NAS	NASSAU
NDJ	N'DJAMENA
NIC	NICOSIA
NIK	NIKOLAEVSK-NA-AMURE
NMY	NIAMEY
NOR	NORILSK
NOV	NOVOSIBIRSK
NUK	NUKUS
NY	NEW YORK
NY	NEW YORK OCEANIC
NZE	NEW ZEALAND
OAK	OAKLAND
OAK	OAKLAND OCEANIC
ODE	ODESSA
OKH	OKHA
OMS	OMSK
ORN	ORENBURG
OSK	OKHOTSK
OSL	OSLO
PA	PUNTA ARENAS
PAN	PANAMA
PAP	PORT-AU-PRINCE
PAR	PARIS
PE	PORT ELIZABETH
PEC	PECHORA
PEM	PERM

ARTCC ABBREVIATIONS (Cont'd)

PEN	PENZA
PER	PERTH
PET	PETERSBURG
PEV	PEVEK
PHN	PHNOM PENH
PIA	PIARCO
PM	PORT MORESBY
PMT	PUERTO MONTT
PRA	PRAGUE
PRM	PARAMARIBO /UTA
PTR	PETROPAVLOVSK-KAM.
PV	PORTO VELHO
PYO	PYONGYANG
REC	RECIFE
RES	RESISTENCIA
REY	REYKJAVIK
RIG	RIGA
RIV	RIVADAVIA
RMS	REIMS
ROB	ROBERTS
ROC	ROCHAMBEAU
ROM	ROME
ROS	ROSTOV
ROV	ROVANIEMI
SAI	SAINSHAND
SAL	SAL OCEANIC
SAM	SAMARA
SAN	SANTIAGO
SCO	SCOTTISH
SDO	SANTO DOMINGO
SEA	SEATTLE
SEM	SEMIPALATINSK
SEY	SEYCHELLES
SHA	SHANGHAI
SHE	SHENYANG
SHN	SHANNON
SHW	SHANWICK OCEANIC
SIM	SIMFEROPOL
SIN	SINGAPORE
SJU	SAN JUAN OCEANIC

ARTCC ABBREVIATIONS (Cont'd)

SKO	SKOPJE
SLC	SALT LAKE CITY
SLK	SALEKHARD
SM	SANTA MARIA OCEANIC
SMR	SAMARKAND
SNA	SANAA
SOF	SOFIA
SON	SONDRESTROM
STA	STAVANGER
STO	STOCKHOLM
SUK	SUKHUMI
SUN	SUNDSVALL
SUR	SURGUT
SWI	SWITZERLAND
SYD	SYDNEY
SYK	SYKTYVKAR
SYM	SEYMCHAN
TAE	TAEGU
TAH	TAHITI OCEANIC
TAI	TAIPEI
TAL	TALLINN
TAM	TAMPERE
TAS	TASHKENT
TAZ	TASHAUZ
TBI	TBILISI
TEH	TEHRAN
TEL	TEL AVIV
TIK	TIKSI
TIL	TILICHIKI
TIR	TIRANA
TOK	TOKYO
TOR	TORONTO
TRI	TRIPOLI
TRO	TRONDHEIM
TUN	TUNIS
TUR	TURUKHANSK
TYU	TYUMEN
UFA	UFA
UJU	UJUNG PANDANG
ULA	ULAANBAATAR

ARTCC ABBREVIATIONS (Cont'd)

UND	UNDERHAAN
URA	URALSK
URU	URUMQI
VAN	VANCOUVER
VAR	VARNA
VEL	VELIKIYE LUKI
VIE	VIENNA
VIL	VILNIUS
VLA	VLADIVOSTOK
VLO	VOLOGDA
VNT	VIENTIANE
VOL	VOLGOGRAD
VRK	VORKUTA
WAR	WARSAW
WAS	WASHINGTON
WEL	WELLINGTON
WIN	WINNIPEG
WND	WINDHOEK
WUH	WUHAN
YAK	YAKUTSK
YAN	YANGON
YEK	YEKATERINBURG
YEN	YENISEYSK
YER	YEREVAN
YS	YUZHNO-SAKHALINSK
ZAG	ZAGREB
ZHK	ZHEZKAZGAN
ZUR	ZURICH
ZYR	ZYRYANKA

OTHER ABBREVIATIONS USED ON KLX 135A PAGES

A	Airport waypoint
A/C	Aircraft
ACQ	Acquisition
ACT	Active flight plan waypoints
ADJ	Adjust
AKD	Alaska Daylight Time
AKS	Alaska Standard Time
ALRT	Alert
ALT	Altitude
APT	Airport
ATD	Atlantic Daylight Time
ATS	Atlantic Standard Time
BARO	Barometric
BRG	Bearing
CAL	Calculator
CAS	Calibrated Airspeed
CDT	Central Daylight Time
CHAR	Character
CL B	Class B Airspace
CL C	Class C Airspace
CRS	Course
CRSR	Cursor
CST	Central Standard Time
CTA	Control Area
DB	Data base
DEGRD	Degraded navigation
DEN	Density Altitude
DIS	Distance
DNGR	Danger Area
DTK	Desired track
DUP	Duplicate
E	East
EDT	Eastern Daylight Time
ELE	Elevation
ENT	Enter
EST	Eastern Standard Time
ETA	Estimated time of arrival
ETE	Estimated time en route
FAILR	Failure of receiver
FPL	Flight plan

OTHER ABBREVIATIONS (Cont'd)

FR	From
GDT	Greenland Daylight Time
GS	Groundspeed
GST	Greenland Standard Time
HAD	Hawaii Daylight Time
HAS	Hawaii Standard Time
HDG	Heading
HLT	Health of space vehicle signal
IDENT	Identifier
IND	Indicated
INIT	Initialization
KT	Knots
L	Left
MAG VAR	Magnetic variation
MDT	Mountain Daylight Time
MSG	Message
MST	Mountain Standard Time
N	NDB waypoint
N	North
NAV	Navigation
NAV A	Navigation with altitude aiding
NAV D	Navigation with data collection
NM	Nautical miles
OBS	Omni bearing selection
ORS	Operational Revision Status
OTH	Other
P.POS	Present position
PDT	Pacific Daylight Time
POS	Position
POSN	Position
PRES	Present
PROH	Prohibited Area
PRS	Pressure Altitude
PST	Pacific Standard Time
PUB	Published
PWR	Power
RAD	Radial
RCVR	Receiver
REF	Reference
REQ	Required

OTHER ABBREVIATIONS (Cont'd)

RES	Reserve fuel
REST	Restricted Area
S	South
S	Supplemental waypoint
SDT	Samoa Daylight Time
SET	Setup
SNR	Signal-to-noise ratio
SST	Samoa Standard Time
SUA	Special Use Airspace
SUP	Supplemental
SV	Space vehicle
SW	Software
TAS	True Airspeed
TEMP	Temperature
TK	Actual track
TMA	Terminal Area
TOT	Total
TRSA	Terminal Radar Service Area
U	User-defined waypoint
USR	User-defined waypoint
UTC	Coordinated Universal Time (Zulu)
V	VOR waypoint
W	West
WPT	Waypoint
Z	Zulu time

This page intentionally left blank

APPENDIX E - LAT/LON CONVERSIONS

The KLX 135A utilizes latitude and longitude expressed in degrees, minutes, and hundredths of a minute. You may occasionally see a document expressing latitude and longitude in degrees, minutes, and seconds. This table may be used to convert seconds to hundredths of a minute.

<u><i>SECONDS (")</i></u>	<u><i>HUNDREDTHS OF A MINUTE (')</i></u>
00	.00
01	.02
02	.03
03	.05
04	.07
05	.08
06	.10
07	.12
08	.13
09	.15
10	.17
11	.18
12	.20
13	.22
14	.23
15	.25
16	.27
17	.28
18	.30
19	.32
20	.33
21	.35
22	.37
23	.38
24	.40
25	.42
26	.43
27	.45
28	.47
29	.48
30	.50
31	.52
32	.53

Appendix

LAT/LON CONVERSIONS (Cont'd)

<u>SECONDS (")</u>	<u>HUNDREDTHS OF A MINUTE (')</u>
33	.55
34	.57
35	.58
36	.60
37	.62
38	.63
39	.65
40	.67
41	.68
42	.70
43	.72
44	.73
45	.75
46	.77
47	.78
48	.80
49	.82
50	.83
51	.85
52	.87
53	.88
54	.90
55	.92
56	.93
57	.95
58	.97
59	.98

For example:

35° 46' 24" is the same as 35° 46.40'

32° 15' 58" is the same as 32° 15.97'

APPENDIX F— GPS PRIMER BACKGROUND

The Global Positioning System (GPS) is a satellite-based navigation system that was originally conceived and implemented by the United States Department of Defense (DoD). The system is, however, available to all civilian users free of charge. GPS provides extremely precise position, velocity, and time information.

The satellites are not geosynchronous, as is the case with many weather and television satellites. That is, each satellite is not above a fixed spot on the Earth all the time, but rather is continuously moving across the sky. In fact, each satellite completely orbits the Earth two times per day.

The Department of Defense imposes an intentional accuracy degradation of the GPS system. This degradation is known as Selective Availability (SA). When SA is active, only U.S. military users have access to full GPS accuracy. For civilian users, position accuracy is degraded to no worse than 100 meters. At the time of this writing, Selective Availability is on (and therefore accuracy is degraded) nearly 100% of the time.

GPS POSITION DETERMINING CONCEPT

The technique used to determine position is fundamentally very simple. The complicated part is accounting for and correcting all the possible errors in the position.

The GPS receiver is able to determine the time it takes a radio signal to travel from the satellite to the GPS antenna. Since this radio signal travels at the speed of light (approximately 186,000 statute miles per second), the time delay can very easily be used to determine the receiver's distance from a given satellite. If measurements are taken from four satellites (or three satellites and an input from an aircraft altimeter), the receiver can identify its position very precisely.

For example, the GPS receiver might determine that it is exactly 12,000 miles from satellite A, 12,700 miles from satellite B, and 13,100 miles from satellite C. At the same time, the aircraft's encoding altimeter might be indicating an altitude of 9,500 feet MSL. There is only one point in space that satisfies these four measurements.

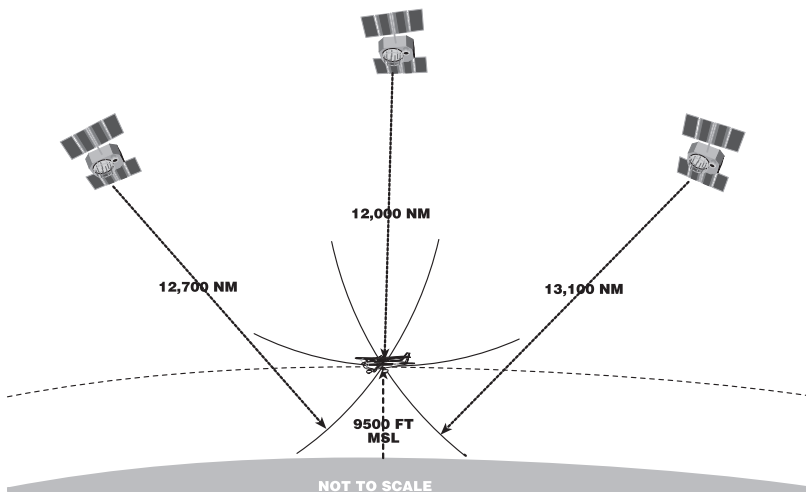

GPS DATA SIGNALS

Two of the primary types of signals that the GPS satellites broadcast are almanac and ephemeris data. These signals enable the GPS receiver to quickly lock on to the satellites in view. Otherwise, the receiver would have to look for each of the 24 satellites to determine which ones could be used.

Almanac data is very crude data which describes the approximate orbital position of the satellites. Each of the 24 satellites transmits the almanac data for all satellites, so a GPS receiver has only to listen to one satellite in order to know which satellites are “visible” (in the sky) at that particular time. Almanac data is good for about six months, so when you turn the receiver off, then back on a month later, it will know what satellites to look for.

Ephemeris data is very precise data which each satellite transmits to tell the GPS receiver exactly where it is and what its orbital parameters will be for about the next four hours. Each satellite transmits its own unique ephemeris data.

GPS SYSTEM SEGMENTS

The GPS system is composed of three segments: the Space Segment, the Control Segment, and the User Segment.

The Space Segment consists of the 24 NAVSTAR satellites which orbit the earth at an altitude of 10,898 nautical miles. The satellite orbits are very precisely planned so that the entire surface of the earth may use the GPS system 24 hours a day, every day. There are almost always more than six satellites in view from anywhere on Earth.

The Control Segment consists of a network of ground-based monitoring and control stations. The Master Control Station is located in Colorado Springs, Colorado. All satellite data which is collected by the other ground stations is assimilated and analyzed at Colorado Springs. Based on these analyses, ephemeris updates (such as system clock corrections) are sent (uplinked) to the satellites through radio transmitters at the ground stations. These ground stations are located at Kwajalein (west of Hawaii in the central Pacific Ocean), Diego Garcia (in the Indian Ocean), and Ascension (in the south Atlantic Ocean).

As an owner of a GPS system, you can now claim to be a certified member of the GPS User Segment! GPS has many users and uses, and more are being dreamed up all the time. Not only are aircraft using GPS navigation, so are military systems and personnel, boaters, hikers, and surveyors. Personal automobiles and transport trucks use Intelligent Transportation Systems, or ITS, to find their destinations, and track their movements. Some biologists attach GPS receivers to animals to monitor their movement and migration patterns. Geologists even use GPS to track the movement of glaciers and to analyze plate tectonics (movements of the Earth's crust). What an exciting new technology as we move into the 21st Century!

This page intentionally left blank

INDEX**A**

Abbreviations

- Airport names 3-25, 3-45
- ARTCC/FIR D-8
- Canadian Province D-2
- Communication frequencies 3-48
- Country D-2
- GPS receiver state 3-57
- Other abbreviations D-17
- State D-1
- Time zones 3-4

ACT (Active waypoint pages) 4-10

Activating

- Numbered flight plan 4-4
- Waypoint in the OBS mode 4-28

Actual track 3-39, 3-41, A-1

Adding waypoints to flight plan 4-2

Airport data

- Bearing and distance 3-46
- City, State (or country) 3-45
- Communication frequencies 3-48
- Identifier 2-4
- Latitude/longitude 3-46
- Military 3-45
- Name 3-45
- Nearest 3-27, 3-46
- Remarks 3-50
- Runway information 3-47

Airport waypoint pages 3-45

Airspeed 4-20, 4-21

Alerting

- Special Use Airspace (SUA) 3-62
- Waypoint 3-35, 4-9

Almanac 3-17, 3-58, F-2

Altitude

- Density 4-19
- Indicated 3-2, 4-18
- Input 1-1, 3-62
- Pressure 3-62, 4-18, 4-19, 4-20

Annunciators, remote 3-61

Antenna 1-1

APT 1 page 3-45

APT 2 page 3-46
APT 3 page 3-47
APT 4 page 3-48
APT 5 page 3-50
ARTCC (Center)
 Abbreviations D-8
 Frequencies 3-31
AUTO map scale 3-42
Autopilot 1-1

B

Baro set 3-2, 3-62
Battery 2-7
Bearing to waypoint 3-37, 3-39, 3-46
Blind tuning of COMM 5-5

C

CAL 1 page 4-14
CAL 2 page 4-16
CAL 3 page 4-18
CAL 4 page 4-19
CAL 5 page 4-20
CAL 6 page 4-20
Canadian province abbreviations D-2
Cancel Direct To operation 3-34, 4-12
CDI
 External 1-1
 Internal 3-35
Characters
 ">" 3-16
 "⊕" 3-35, 4-8
 "*" 3-58
 "+" 3-8
 "R" 5-4
 "T" 5-4
City of airport 3-45
Clear button 3-10, 3-16
COMM operation 5-1
 Active frequency entry 5-2
 Blind tuning 5-5
 Channel spacing 5-2
 Controls 5-1, 3-0
 Entering frequencies 5-1
 Frequency selection from data base 5-3
 QuickTune™ frequency selection 5-3

- Receive/Transmit "R" and "T" annunciations 5-4
- Squelch 5-4
- Standby frequency entry 5-1
- Stuck microphone 5-4
- Turn-on 3-2
- Volume adjustment 5-4
- Communication frequencies
 - Airports 3-49
 - Centers 3-31
 - Flight Service Stations 3-30
- Computer data base, updating 2-5
- Controls 3-0
- Country abbreviations D-2
- Coverage area
 - Data base 2-0
 - GPS 3-1, 4-29
- Change first waypoint identifier character 3-14
- Creating
 - Flight plans 4-1
 - User waypoint at known latitude/longitude 4-23
 - User waypoint at present position 4-22
 - User waypoint from another waypoint 4-24
- Crosstrack distance 3-36, A-1
- CRSR button 3-10
- CTA 3-49
- Cursor 3-10
- Cyclic field (>) 3-16

D

- Data base
 - Airports 3-45
 - Contents 2-1 Functions 2-1
 - Geographical regions 2-0
 - ICAO identifiers 2-3
 - NDBs 3-52
 - PC interface kit 2-4
 - Subscriptions and update options 2-8
 - Updating 2-4, 2-7
 - User waypoints 3-53
 - VORs 3-51
- Data entry 3-12
- Date and time 3-3, 3-55
- Display format 3-7
- Default first waypoint identifier character 3-14

Deleting

Airport and user waypoint remarks 3-61

Direct To operation 3-34, 4-12

Flight plans 4-7

User waypoints 3-59

Waypoints from flight plan 4-6

Departure time 3-40

Desired track (DTK) 3-39, 3-40, 3-42, 4-4, 4-12, A-1

Direct To operation

Canceling Direct To 3-34, 4-12

NAV 1 page in Direct To 3-33, 3-35

Procedures 3-33

Recent D-bar 3-34

Using with flight plan operation 4-11

Waypoint alerting 3-35

Disable turn anticipation 4-10

Distance 3-37, 3-40, A-1

Duplicate waypoint page 3-15

E

Editing

Flight plans 4-5, 4-6

Emergency nearest airport 3-267

Enter (ENT) button and prompt 3-10, 3-11

Entering

Airport remarks 3-50

Frequencies 5-1

User waypoint remarks 3-54

Waypoint identifiers 3-13

Estimated position error (EPE) 3-57

Erase; See Delete

ETA (Estimated time of arrival) 3-39

ETE (Estimated time en route) 3-37, 3-40

F

Flight plans

Activating 4-4

Active flight plan 4-1, 4-8

Adding waypoints 4-2

Creating 4-1

Deleting 4-7

Deleting waypoints 4-6

Direct to operation in flight plans 4-11

Editing 4-5, 4-6

- Flight plan 0 (active flight plan) 4-1, 4-8
- Inverting 4-5
- Operating from the active flight plan 4-8
- Rules for use of 4-8
- Storing active flight plan as a numbered flight plan 4-7
- Viewing distance, ETE, ETA, and DTK of flight plan waypoints 4-4, 4-12
- Viewing waypoint pages for active flight plan 4-10
- Flight time 3-39
- FPL 0 page 4-8
- FPL 1-9 pages 4-1
- Frequencies for airport communications 3-48
- Frequency entry 5-1
- Frequency selection from data base 5-3
- FSS frequencies 3-30
- Fuel planning 4-16

G

GPS

- Coverage area 3-1
- Panel controls 3-0
- Receiver status 3-57, 3-58
- Theory of operation F-1

Groundspeed 3-37, 3-40

H

- Heading 4-218
- How-To Index iv
- HSI 1-1

I

- ICAO identifiers 2-4
- Initial position 3-6, 3-18
- Initialization 3-3, 3-17
- Initialization page 3-3
- Interfaces 1-1
- Inverting flight plans 4-5

J

K

- KA 92 antenna 1-1

L

Latitude/longitude conversion table E-1
Leg mode 4-26
Lighting, runway 3-48

M

Magnetic variation 4-29
Map display 3-39
Message (MSG) button, prompt, and page 3-10, 3-11, 3-17
Modes, navigation
 OBS 4-27
 Leg 4-26
 Selecting Leg or OBS mode 4-26

N

Name of navaid or airport 3-45, 3-50, 3-52
NAV 1 page 3-35
NAV 2 page 3-38
NAV 3 page 3-39
NAV 4 page 3-39
NAV 5 page 3-40
Navigation map display 3-40
Navigation pages
 Angles (NAV 4 page) 3-39
 Moving map (NAV 5 page) 3-40
 Present position (NAV 2 page) 3-38
 Primary navigation (NAV 1 page) 3-35
 Times relating to navigation (NAV 3) 3-39
Navigation terminology A-1
NDB 1 page 3-51
NDB 2 page 3-52
NDB data
 Bearing and distance 3-52
 Frequency 3-51
 Identifier 3-51
 Latitude/longitude 3-52
 Name 3-52
 Nearest 3-26
Nearest
 Centers 3-31
 Flight Service Stations 3-30
 Special Use Airspace 3-29
 Waypoints 3-26

O

OBS mode 4-27
Operating from active flight plan 4-8
ORS (Operational Revision Status) Cover, 3-2
OTH 1 page 3-57
OTH 2 page 3-58
OTH 3 page 3-59
OTH 4 page 3-60
OTH 5 page 3-61

P

Page number on display 3-10
Page organization 3-10
Page selection 3-11
PC interface kit 2-5
PC requirements for updating data base 2-5
Plus sign (+) meaning 3-10
Prefixes for airport identifiers 2-4
Present position 3-8, 3-38

Q

QuickTune™ frequency selection 5-3

R

“R” receive annunciation 5-4
Receive/Transmit annunciation 5-4
Radial from a waypoint 3-37, 3-38
Receiver status 3-57, 3-58
Remarks
 Airport page 3-49
 User waypoint page 3-54
Runway information 3-47

S

Sample trip 3-64
Satellite status 3-58
Scanning waypoint names 3-22
Scratchpad messages 3-11
Screen organization 3-9
Selected course, See OBS mode
Selecting
 Waypoints 3-20, 3-21, 3-22, 3-23
Self-test 3-2

SET 1 page 3-18
SET 2 page 3-55
SET 3 page 2-5
SET 4 page 4-10
SET 5 page 3-13
SET 6 page 3-27
SET 7 page 3-63
SET 8 page 3-62
Set date and time 3-3, 3-55
Simulator (Take-Home mode) 4-30
Sneak Preview of operation ii
SNR (Signal-to-noise ratio) 3-58
Software status 3-61
Special use airspace 3-29, 3-61
Squelch 5-4
Stuck microphone 5-4
State abbreviations D-1
SUP 0 page 3-52
SUP 1 page 3-53
SUP 2 page 3-53
SUP 3 page 3-54
Surface, runway 3-48
System components 1-1, 1-2

T

“T” transmit annunciation 5-4
Take-Home mode 4-30
Take-Home warning page 3-2
Time
 Actual 3-4, 3-39, 3-56
 Departure 3-39
 ETA 3-39
 ETE 3-37, 3-40
 Flight 3-39
 Setting 3-4, 3-56
Time to first fix 3-17
Time zones 3-5
TMA 3-48
To/From indicator 3-36
Track; See Actual Track
True airspeed 4-20, 4-21
Turn anticipation 4-9
Turn-on 3-1
Turn-on page 3-2
Trip planning 4-14, 4-16

U

Updating the data base 2-4
User waypoints
UTC; See Time zones

V

Volume adjustment 5-4
VOR 1 page 3-50
VOR 2 page 3-51
VOR data
 Bearing and distance 3-51
 Frequency 3-51
 Identifier 3-50
 Latitude/longitude 3-51
 Magnetic station declination 3-51
 Map display of 3-44
 Name 3-50
 Nearest 3-26

W

Waypoint alerting 3-35, 4-10
Waypoint identifier entry 3-13
Waypoint identifiers 2-4
Waypoint pages
 Active waypoint 4-10
 Airport 3-45
 NDB 3-51
 Selecting waypoint pages 3-20, 3-21, 3-22, 3-23
 User-defined waypoint/SUP 3-52
 VOR 3-50
Waypoint scanning window 3-44
Waypoints
 Adding to flight plan 4-2
 Creating user waypoint 4-30
 Deleting from flight plan 4-6
 Deleting user waypoint 3-59
 Duplicate 3-15
 "From" and "To" waypoints 3-33, 3-35, 4-8
 Selecting and scanning 3-20, 3-21, 3-22, 3-23
 Viewing user waypoints 3-59
 Viewing waypoint in active flight plan (FPL 0) 4-10
Wind 4-21

Index

X

Y

Z

Index